

Montage type:

2

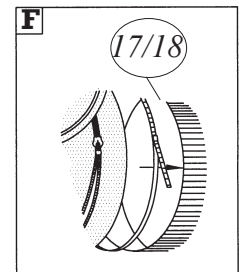

min/mtr.

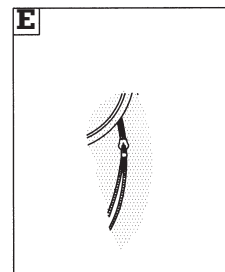
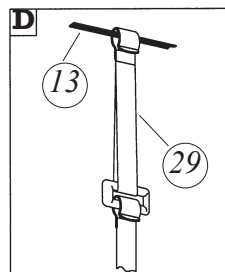
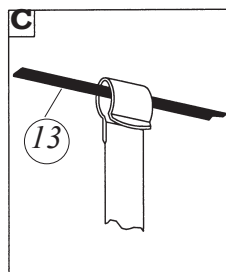
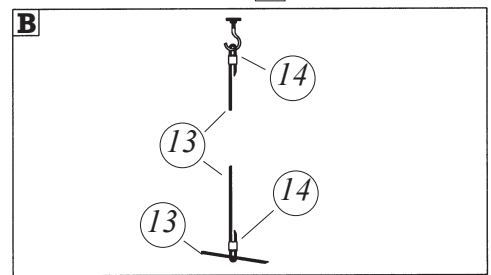
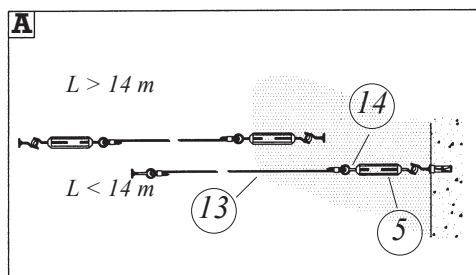
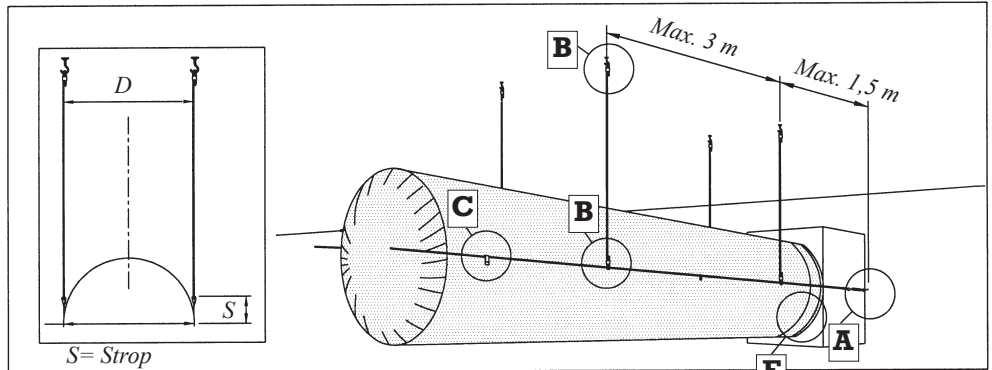
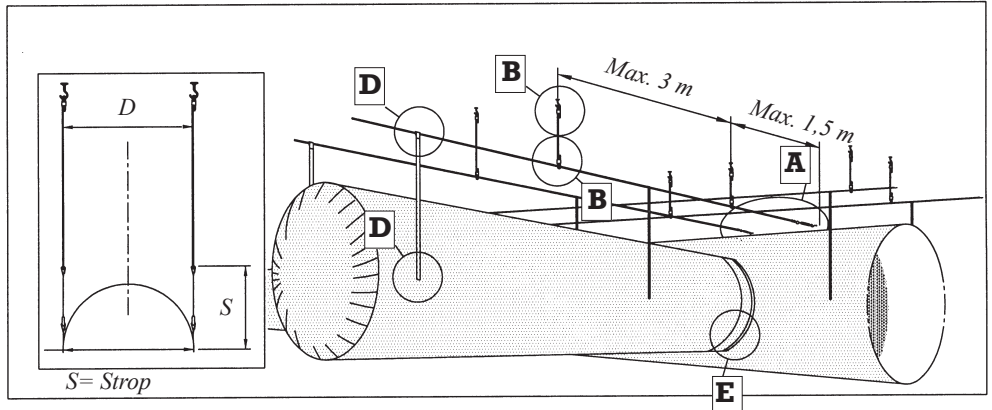

Standard



Wire strammer

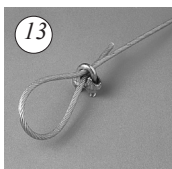

Wire



Wire l s 3/16"



B ndsp nde
No. 17 - max. dia. 500 mm



Ludhof sele
No. 18 - dia > 500 mm

FabricAir