

Type 6

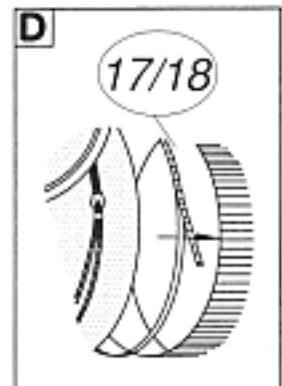

Optional

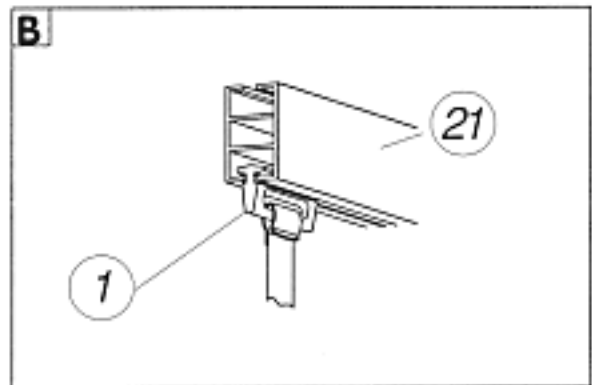
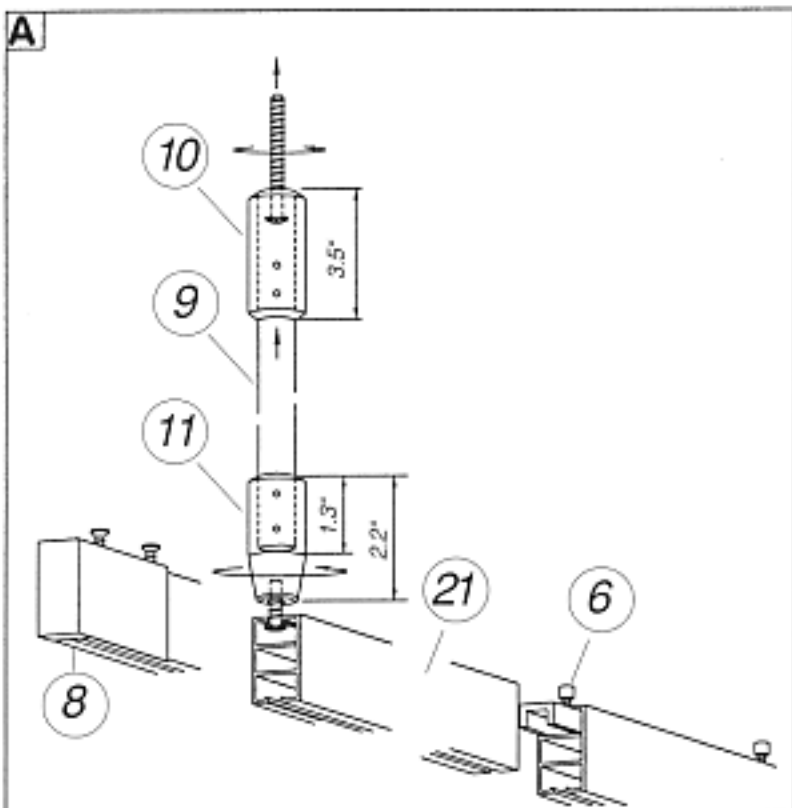
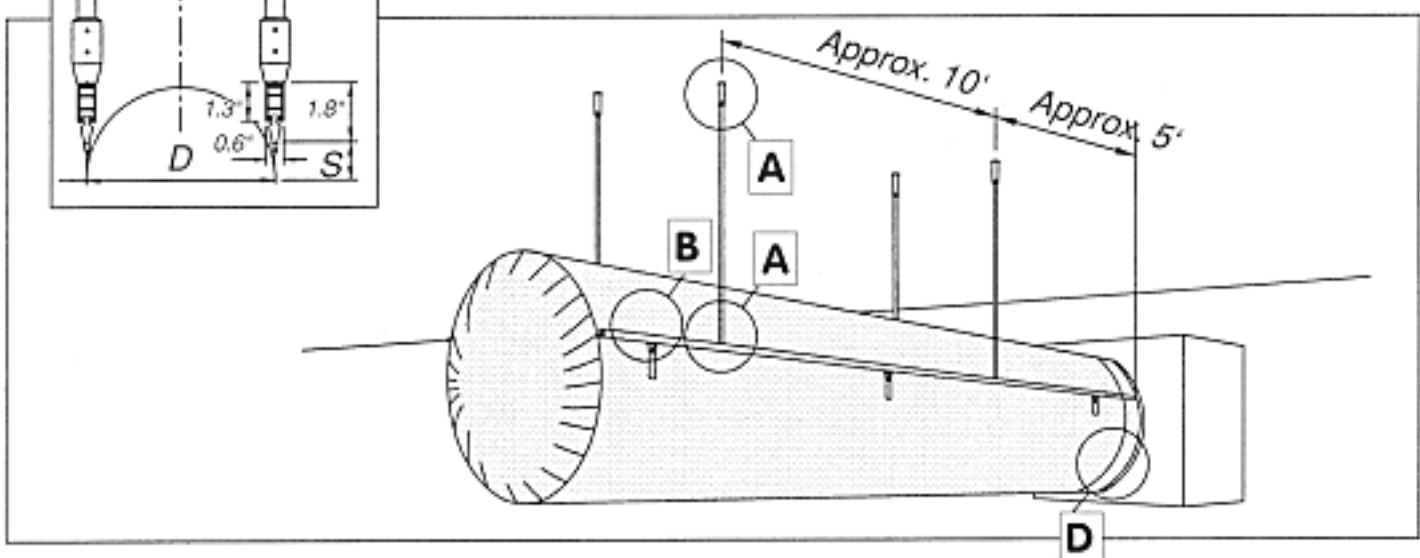
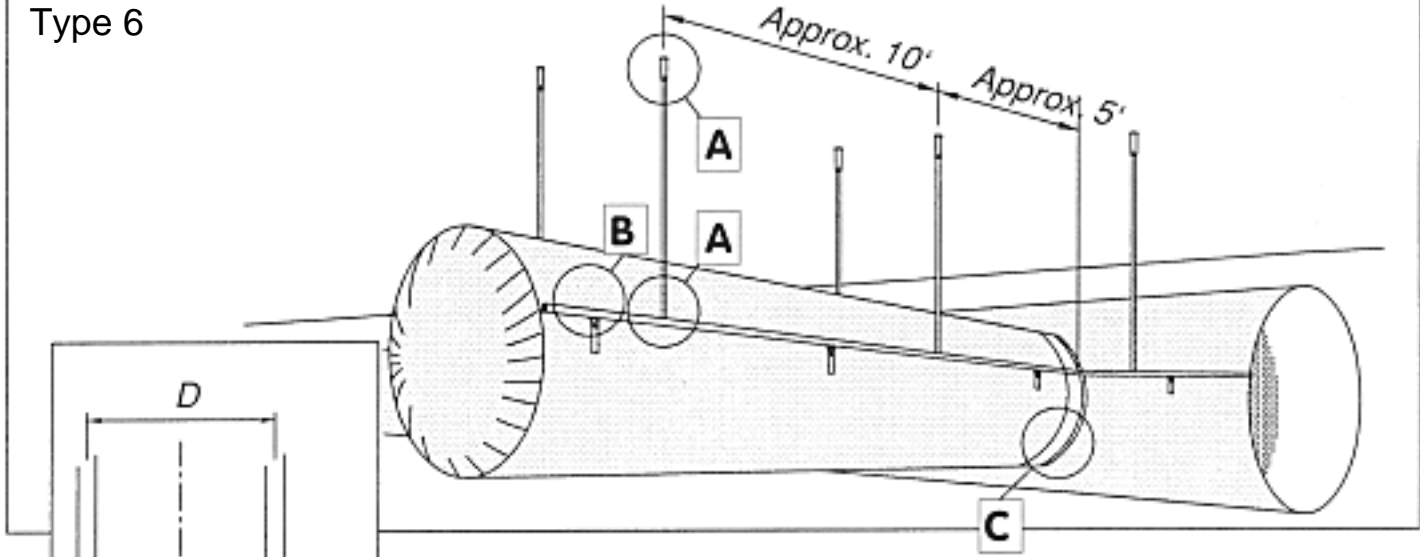

Joiner for H-Rail

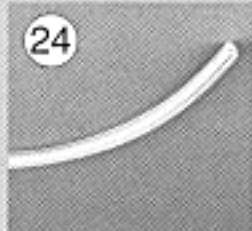

Sealer for H-Rail

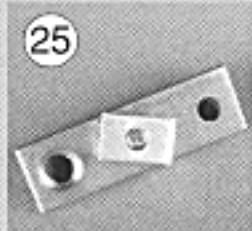

Ceiling anchor for H-Rail

Choosing no. 25 makes nos. 9,10 and 11 unnecessary. In this case they will not be included in the shipment

Standard



Glider

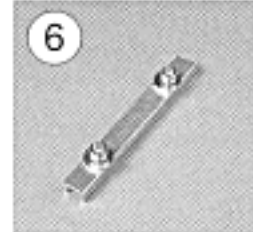

Rail Joint

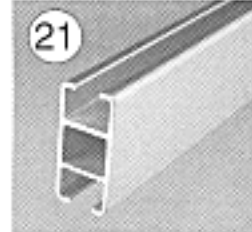

IPS H-Rail

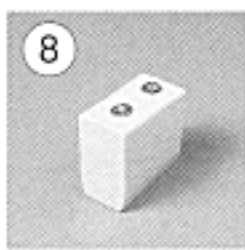

Rail End Cap

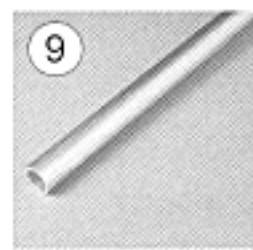

Suspension Tube



Tie down Strap
No. 17 - max. dia. 20 inches



Tie down Strap
No. 18 - dia > 20 inches



Suspension Tube attachment, top



Suspension Tube attachm., bottom