

-fabricAir

FABRICAIR® DUCTING

Simplicity • Performance • Aesthetics

smart air
solutions.



EN





Table of Contents

WHY FABRICAIR® DISPERSION TECHNOLOGY?

| | |
|---------------------------------------|----|
| Why Fabric? | 4 |
| Advantages of FabricAir® Ducting..... | 6 |
| Save Up to 70% | 7 |
| Fast & Easy Installation | 8 |
| Freedom in Design..... | 10 |
| Versatile System Design..... | 12 |

FABRICAIR® DISPERSION TECHNOLOGY

| | |
|---|-----------|
| Overview: FabricAir® Dispersion Technology | 14 |
| Duct Profiles | 16 |
| Round FabricAir® Ducts..... | 18 |
| D-Shaped / Half-Round FabricAir® Ducts | 20 |
| Circle Section FabricAir® Ducts | 22 |
| Rectangular FabricAir® Ducts..... | 24 |
| Shape Retention Options..... | 26 |
| Fabrics..... | 28 |
| FabricAir® Combi..... | 30 |
| FabricAir® Lite..... | 32 |
| FabricAir® Glass 220..... | 34 |
| FabricAir® Poly | 35 |
| Custom Colors, Special Dyes & Surface Print..... | 36 |
| Artwork, Logos & Lettering..... | 38 |
| Flow Models..... | 40 |
| Overview: Surface and Directional Flow Models | 42 |
| FabFlow™ | 44 |
| MicroFlow™ | 46 |
| PerfoFlow™..... | 48 |
| SonicFlow™..... | 50 |
| OriFlow™ | 52 |
| NozzFlow™ | 54 |
| JetFlow™ | 56 |
| Suspension Systems..... | 58 |
| Cable Suspension..... | 60 |
| HE Suspension..... | 62 |
| H-rail Suspension | 64 |
| T-rail Suspension..... | 66 |
| Overview: Suspension Types..... | 68 |
| Specialty Products | 70 |
| FabricAir® VarioDuct™..... | 71 |
| FabricAir® DefrostDuct™ | 72 |

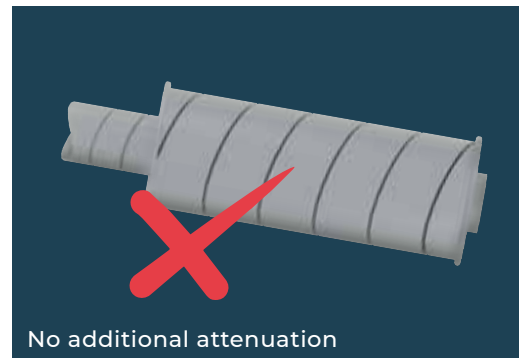



Why fabric?

Anywhere you can use exposed sheet metal ducting, you achieve savings and design advantages by switching to fabric ducting.

The versatility and flexibility of a FabricAir® Dispersion System is greater than that of a conventional metal solution.

The technology does not require balancing, and the need for dampers is minimal.

The technical properties of a FabricAir® Dispersion System are unrivaled:

- No condensation problems
- Even air distribution
- Fireproof materials
- Excellent sound-technical properties
- Hygienic and easy to maintain

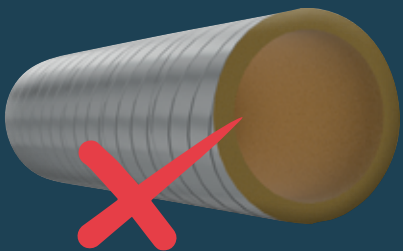

No insulation



Fast and easy installation

FabricAir® dispersion technology is all inclusive. This means less hassle and optimized indoor air quality.

smart air
solutions.

Advantages of FabricAir® Ducting

Draft-free, even air distribution

FabricAir® technology ensures even air distribution with no uncomfortable drafts. The customized design takes all relevant room dimensions and requirements into consideration to create the optimal solution.

Fast & easy installation

Installing a FabricAir® Dispersion System is 4 to 5 times quicker than installing conventional metal solutions. No special tools are needed; the ducts are designed and made to measure, weigh significantly less and do not require balancing.

Best lead times on the market

Optimized design and production processes ensure that the air dispersion solution typically arrives on site in 2-3 weeks from the time the order is released.

Energy efficient solution

Using FabricAir® technology saves up to 40 % on the running costs of a ventilation system due to the precision of the airflow and the lower pressure loss.



SAVE UP TO 70%

Switching from conventional metal ducting to FabricAir® dispersion may save you up to 70% on total installed costs. The total savings potential on a project varies from 30% to 70% over the cost of conventional solutions.

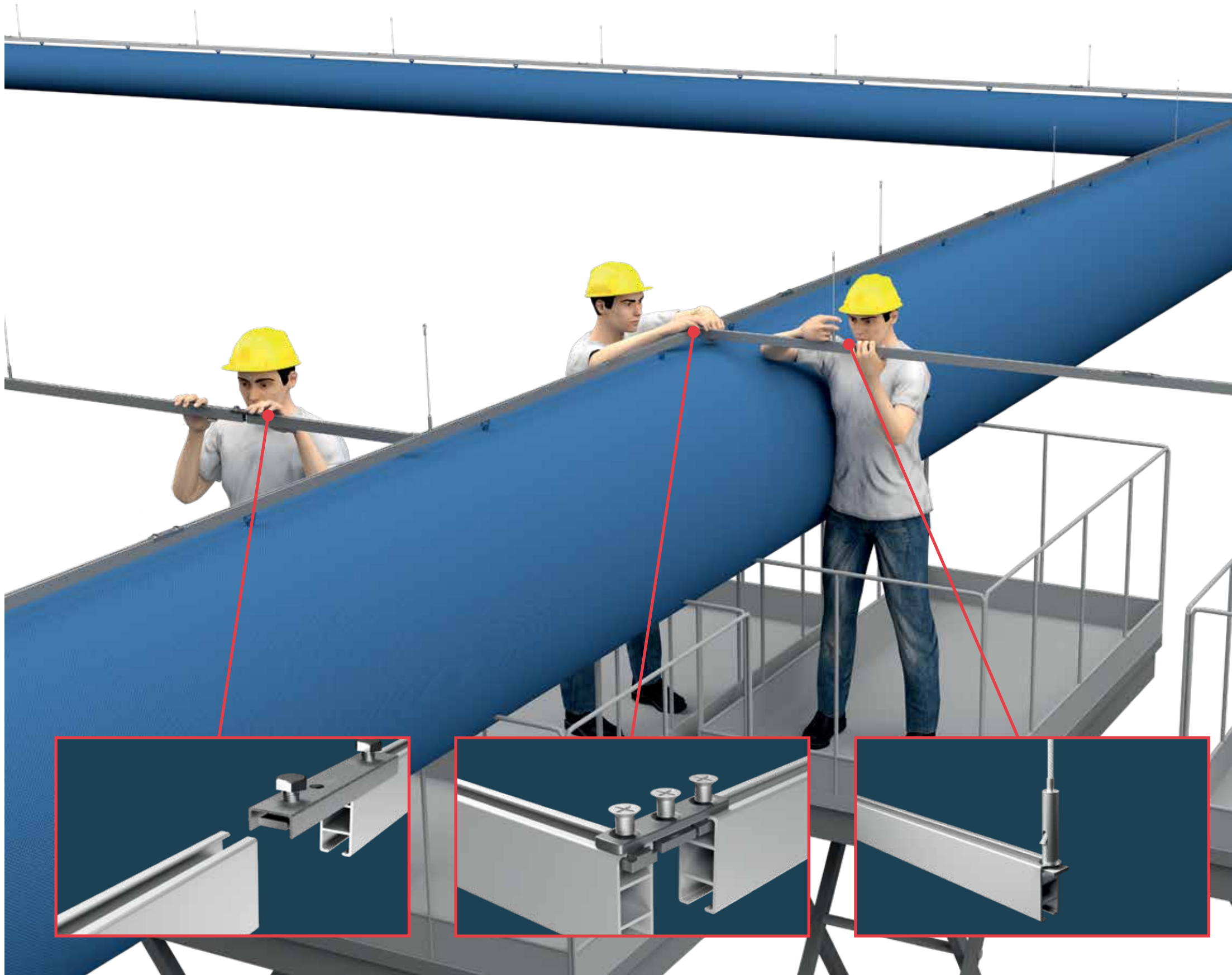

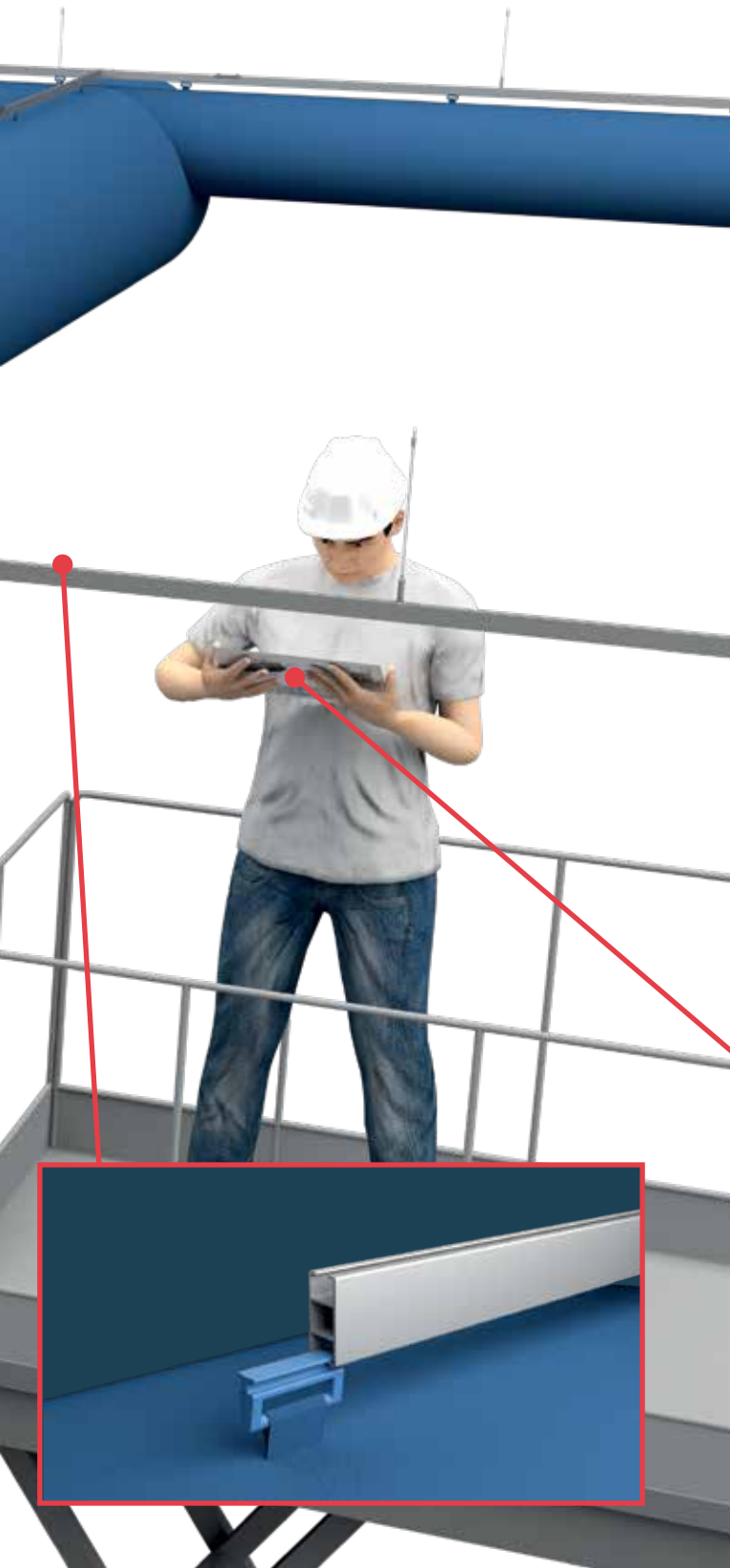

Fast & Easy Installation

Ease of installation is a hallmark of FabricAir® dispersion technology. The savings potential is significant: up to 80% of installation time and labor costs. Installing FabricAir® solutions is 4 to 5 times quicker than installing an equivalent conventional solution.

The secret is in the technology. The ducts are tailored to the project, typically weigh less than 3 kg per linear meter [less than 2 pounds per linear foot] and do not require on-site attenuation, balancing, insulation or painting. We call this air dispersion all-inclusive.

The suspension is installed using only common tools available in any toolbox – a screwdriver, a drill and a handsaw. Once the rail or cable is mounted, adding the ductwork is as easy as sliding a shower curtain.

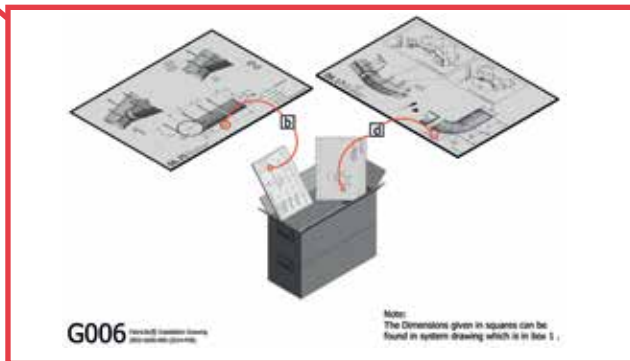

Once produced, the air dispersion system undergoes final inspection, and a full overview of all order items listed by box number is created. This overview is always added as a checklist in Box No. 1 along with relevant documents like installation guide, laundry and maintenance manuals and the spec drawings.

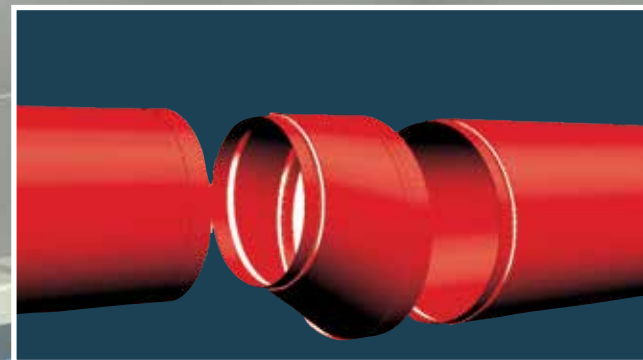



Freedom in Design

FabricAir® Dispersion Systems allow for aesthetic expression and design in shapes, transitions, profiles and flow models to create a clean and attractive appearance that unlike conventional metal solutions are free from joints, corrugations, duct sealant, paint streaks or inconsistencies.

Because fabric ducts are not restricted to standard elbows and lengths, the product offers complete freedom in design.

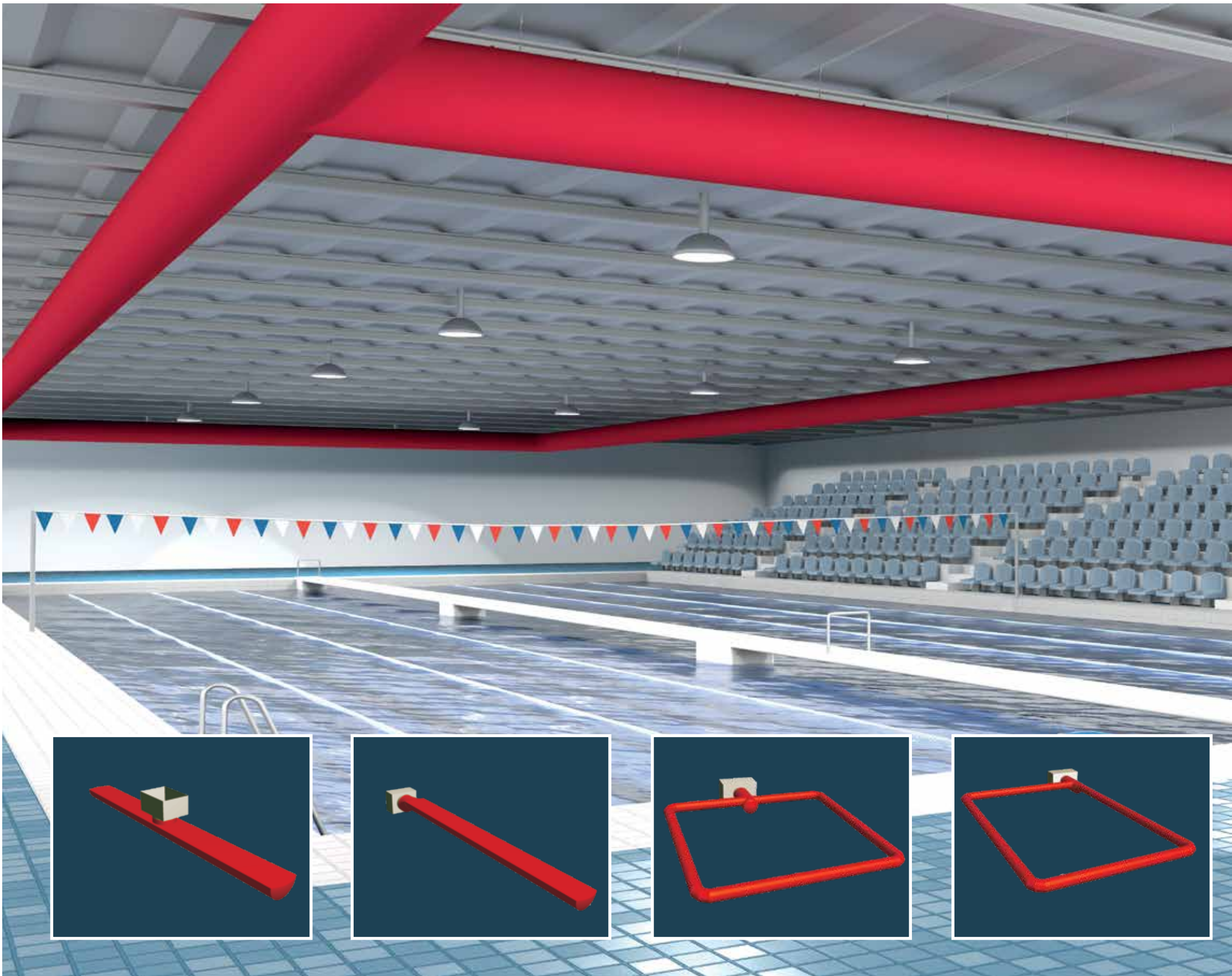



Versatile System Design

Infinite design possibilities make it easy to create a ventilation solution that suits the layout of any building perfectly when using FabricAir® dispersion technology.

Individual solutions are custom designed using proprietary 3D software, CFD analysis and more than 50 years of air engineering expertise to ensure the ideal airflow for each application. All systems are tailor-made at our production facility in Lithuania.

The result is a fabric-based air dispersion solution that delivers the ideal indoor environment irrespective of whether the application is isothermal, heating, cooling or a combination thereof.

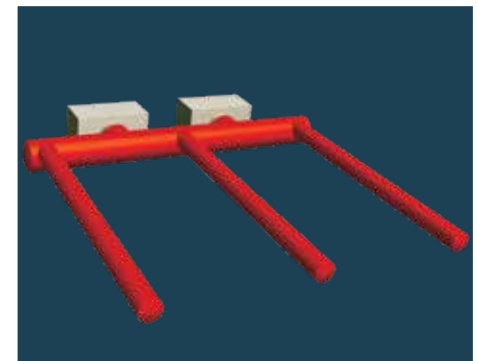
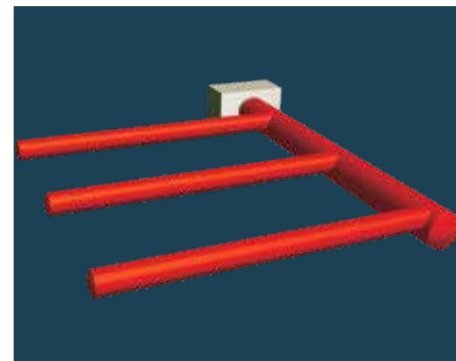
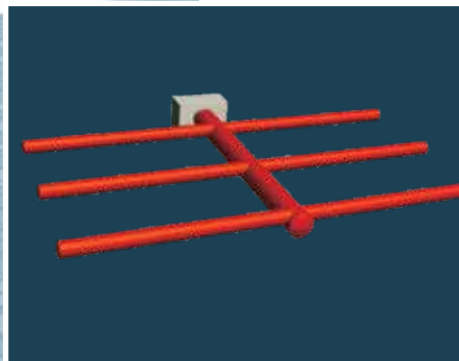
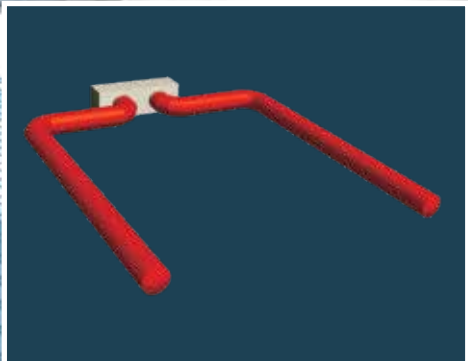

smart air
solutions.

FabricAir® Dispersion Technology

— THE FUTURE OF HVAC/R

A FabricAir® Dispersion System consists of four elements: profile, fabric, flow model and suspension. These may be combined in infinite ways to match the specific requirements of any given project.

COMPONENTS OF FABRIC DUCTING:

PROFILES

The correct duct profile is determined by factors such as room dimensions, air volume, aesthetics and more. We offer standard and customized profiles to ensure the best fit for any application.

FABRICS

A wide variety of woven materials are available for any application. The woven fire-retardant material can also be anti-microbial.

FLOW MODELS

The airflow in a given space is affected by many factors. Thus, we offer unique combinations of flow models based on different air dispersion principles and throw lengths depending on the project.

SUSPENSIONS

A wide variety guaranteed to meet the challenges of any installation.

Zip fastener

The sections are assembled with discreetly hidden zip fasteners.

Shape retention

All-in-One Support or Internal 360° Hoops can be added to keep the duct open when the airflow is off.

Tag number

Each duct section is labeled with a tag number, which indicates the order of assembly. It contains an ID number, which makes tracking easy.

Safe mounting

Fabric ducts connected to metal spigots are secured using a fixing strap.

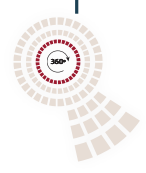
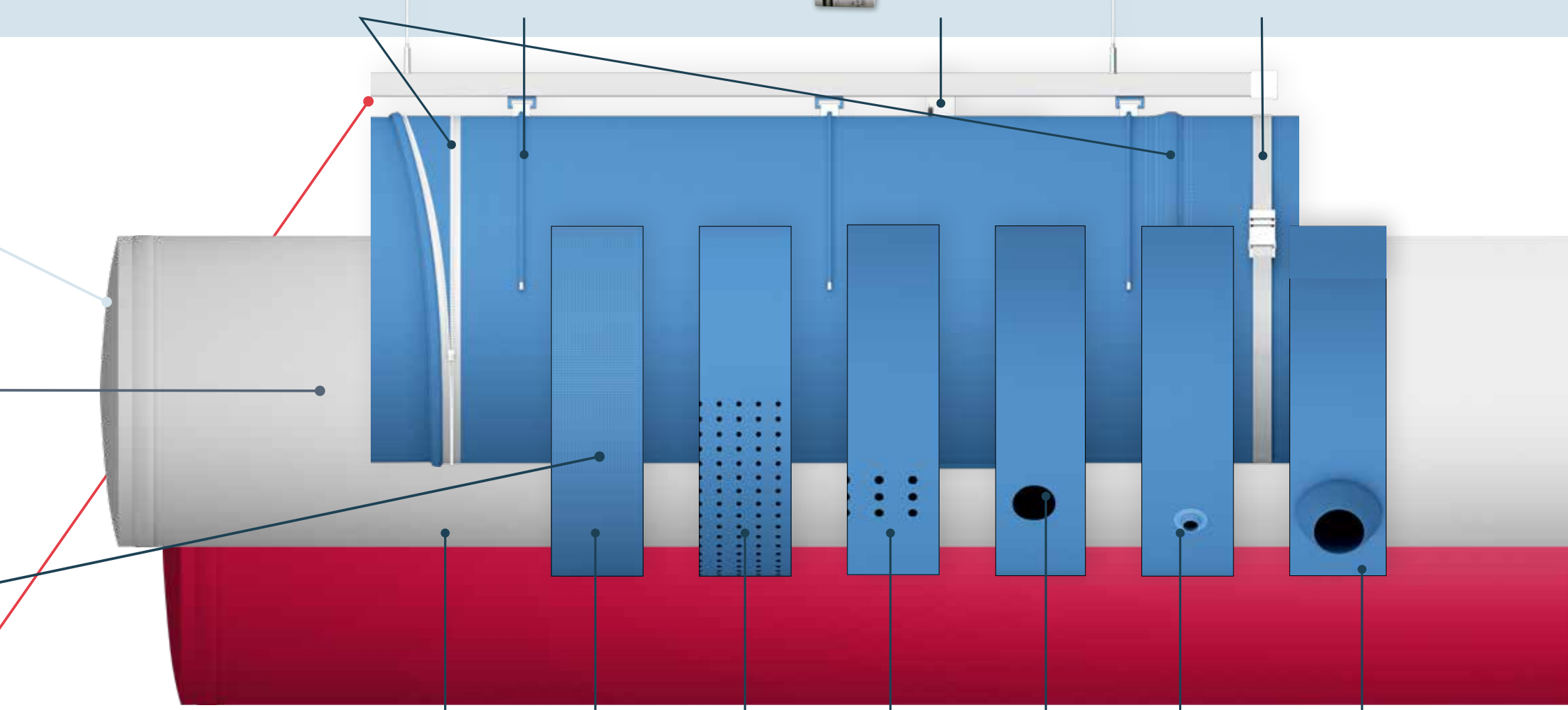

FabFlow™
The air is distributed through the entire surface of the fabric.

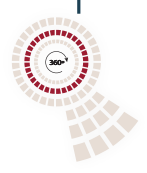

MicroFlow™
The air is distributed through micro-perforations.

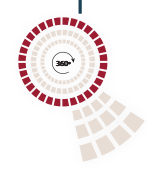

PerfoFlow™
The air is distributed through small orifices.

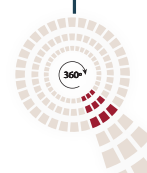

SonicFlow™
The air is distributed through lengthwise rows of small orifices.

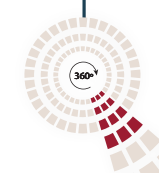

OriFlow™
The air is distributed through large orifices.



NozzFlow™
The air is distributed through venturi shaped plastic nozzles with excellent discharge coefficients.



JetFlow™
The air is distributed through jets, which provide exceptionally long throws for large spaces.

Duct Profile: Round

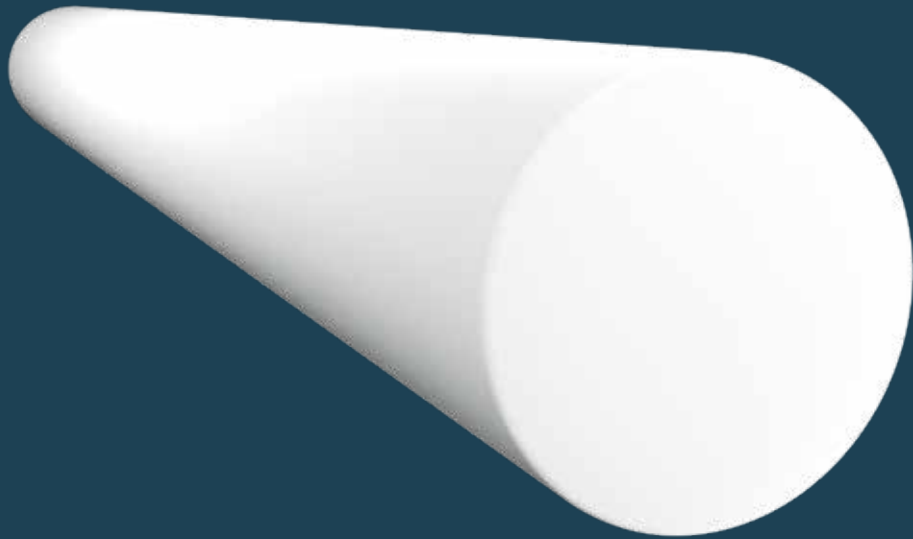

Duct Profile: D-Shaped / Half-Round

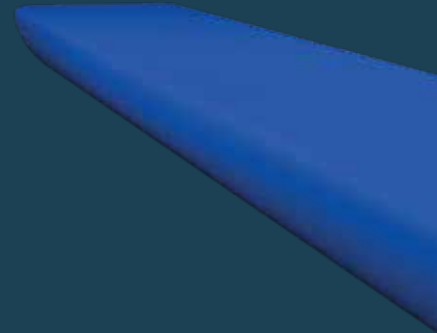

Duct Profile: Circle Section

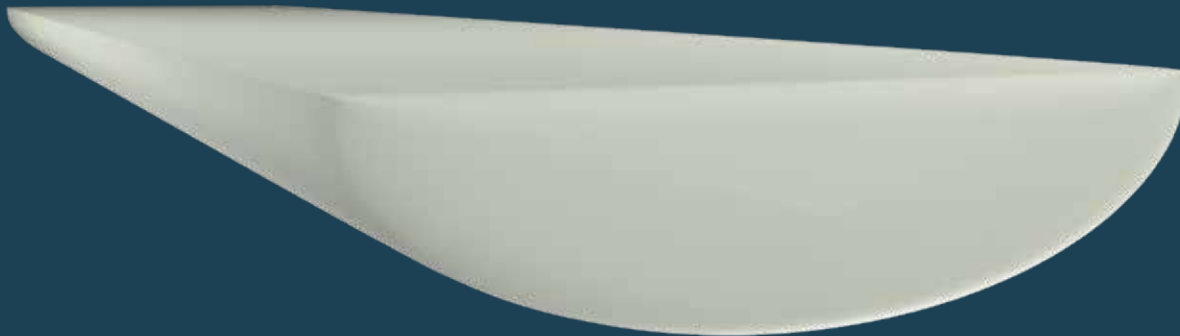

Duct Profile: Rectangular



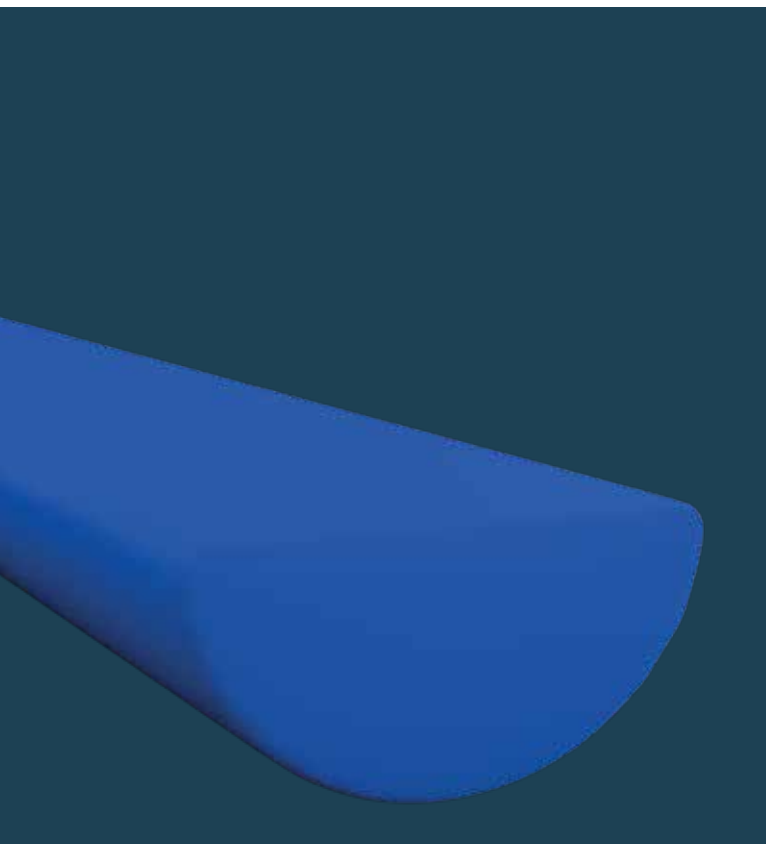

DUCT PROFILES

FabricAir® offers a number of duct types for various purposes.

Classic fabric ducting comes in a wide assortment of duct profiles in addition to the round and D-shaped favorites; whereas the specialized ducts are round. Customized duct profiles are tailored to the specific project challenges. To inquire about customized solutions please contact your local FabricAir® office.

Our engineers design the air dispersion system to ensure the best possible fit for each individual application. Influencing factors, like room dimensions, air volume and aesthetics, and purpose of the solution are thoroughly evaluated to select the appropriate duct type and profile.

Our engineering experts call on a proven 50-year track record and accumulated know-how in the field of air engineering to create the ideal solution.

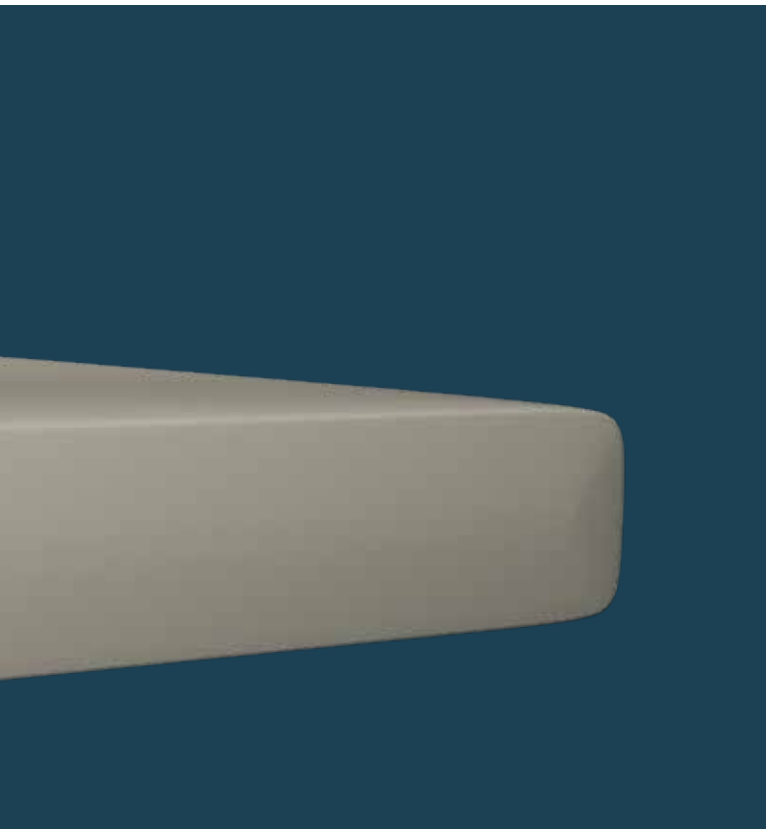

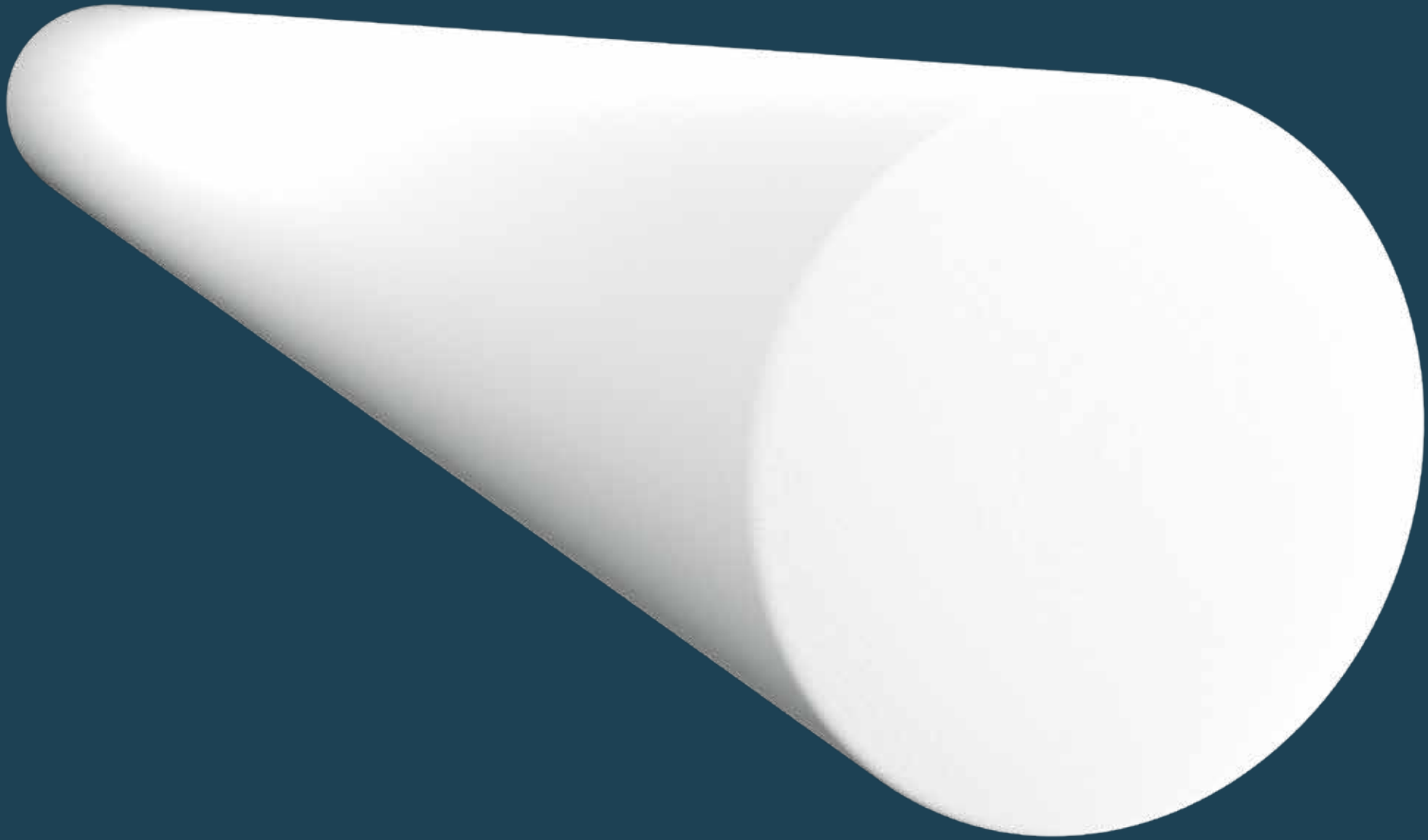

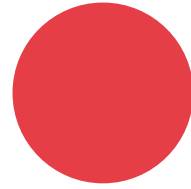

Round

The round duct profile is the most commonly used of all profiles. It is typically found in open ceiling applications, where ceiling height is not an issue.

The duct diameter can be made as small or as large as required. Using the shape retention accessories will keep the duct profile round even when the air is off, preventing the duct from collapsing.

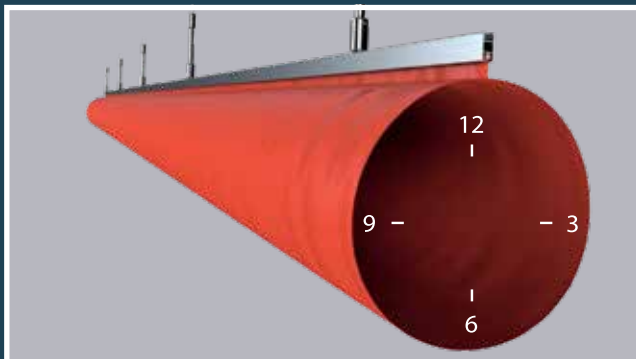

When working with round profiles, we use clock positions to determine the placement of the appropriate flow model(s). We always determine clock positions with the airflow coming from our back.

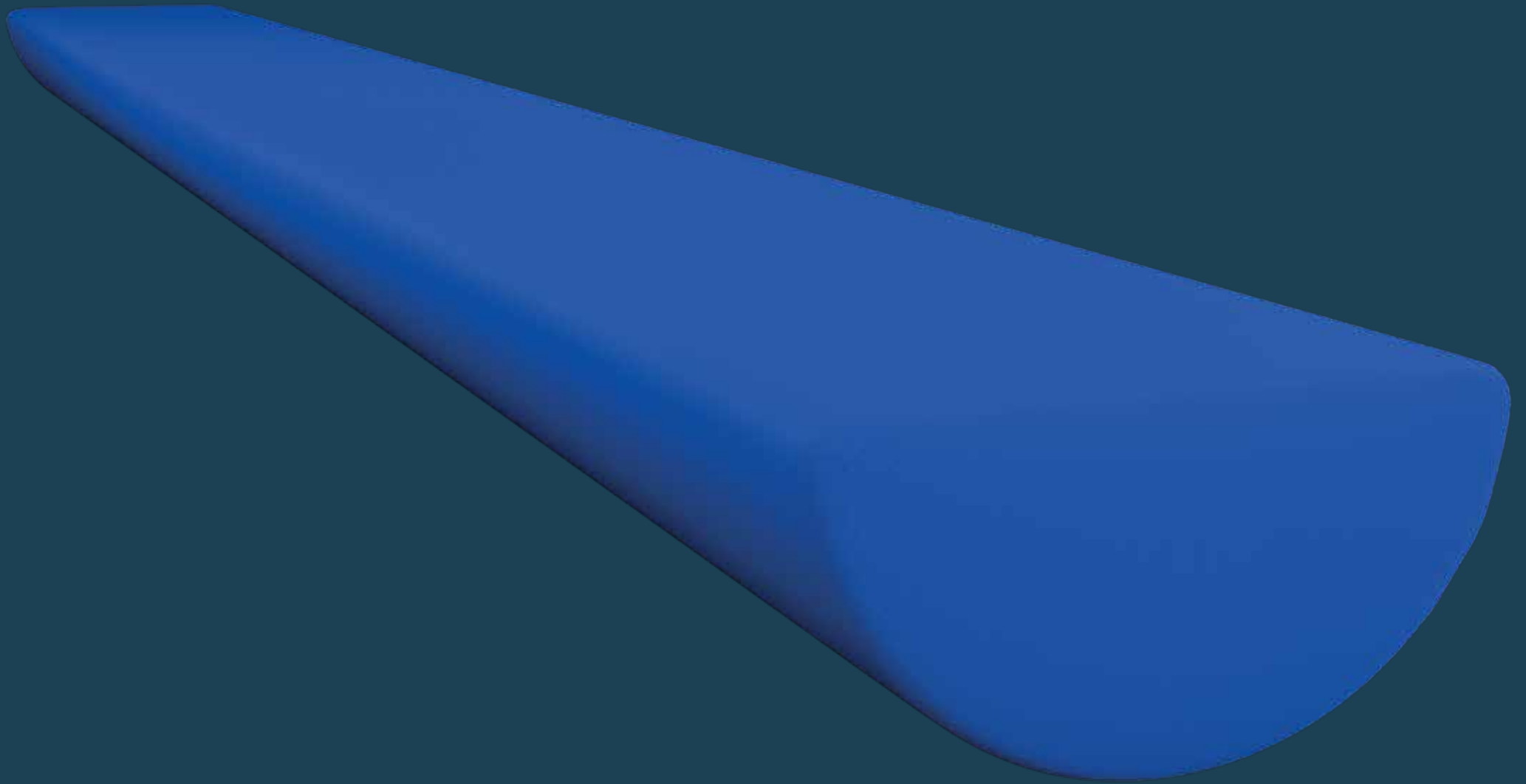



D-Shaped and Half-Round

Half-round ducts can be used where the suspension can be installed directly onto ceilings and walls. This duct profile is typically used in applications with ceiling height restrictions or to make the duct appear to be part of the ceiling rather than hanging free in the space.

D-shaped ducts are a discreet and aesthetic choice, as they keep the same shape with and without airflow.



Commonly seen in classrooms, offices and retail applications, these slim profile types use very little space to create the perfect airflow for comfort. In combination with directional throws, these profiles are a solid choice in applications with ceiling height restrictions.





Circle Section

The circle section duct profile can be used where the suspension can be installed directly onto ceilings and walls. Typically, this profile is used when there is not enough headroom to allow for the use of a half-round duct, for example in applications with specific height restrictions, such as laboratories, high storage or server rooms. The profile can be wider, yet less deep compared to the classic D-shape.

Circle sections may also be an aesthetic choice, as they keep their shape regardless of active or deactivated airflow.



Commonly seen in storage, laboratories and server room applications, circle sections use very little space to create the ideal airflow. When designed with directional throws, these duct profiles ensure excellent mixing and an even air dispersion despite their slim nature.

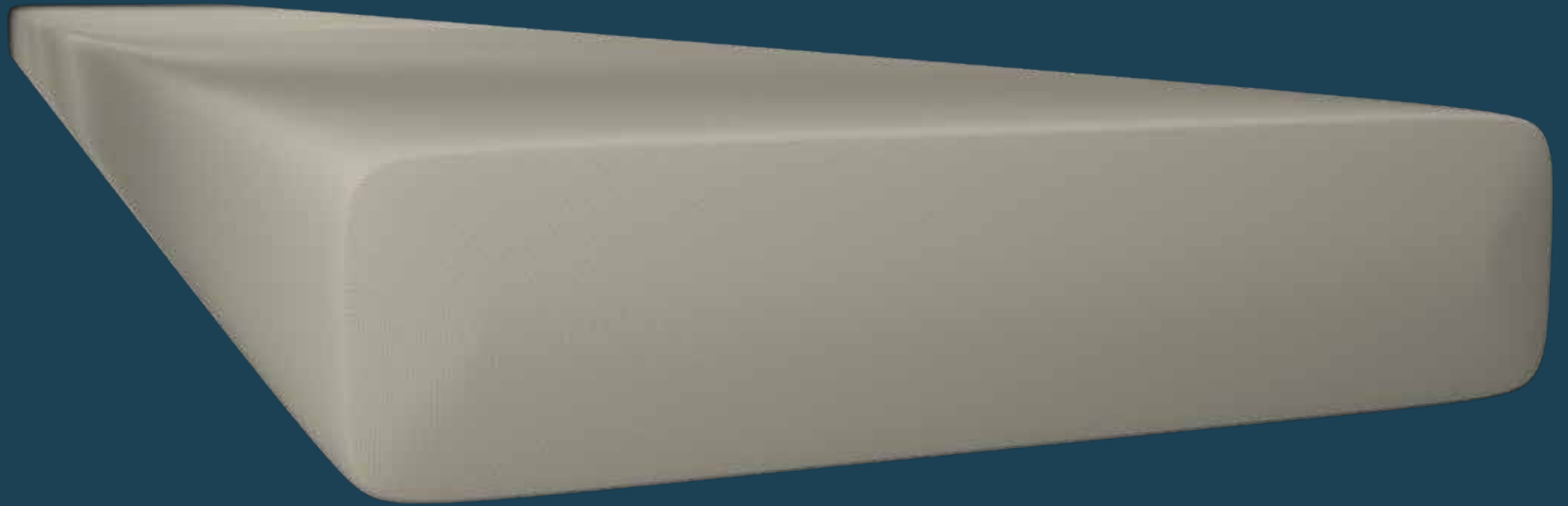



Rectangular

The FabricAir® rectangular duct is a fully customizable duct option, available with all flow models and fabric types except FabricAir® Poly.

This duct profile is typically required when there is not enough space to fit a round duct suited for the desired air volume, or when the application calls for separate temperature zones inside the duct.

FabricAir® will custom design the duct based on the requirements of the specific project.



Rectangular ducts are typically created using internal membranes for structural integrity, and support hoops may be used on all four sides. This ensures that the duct keeps its profile when the air is turned on, despite the natural pressure toward bulging.

Shape Retention Options

Shape Retention Options ensure better looking ducts in periods when the ventilation system is turned off. With Internal 360° Hoops the duct is kept round regardless of whether the system is active; with All-in-One Support only a slight change of the circular shape occurs when the air is shut off. Taut Endcap provides a smooth endcap and aesthetically pleasing appearance regardless if the system is on or off. All accessories also minimize the shock associated with inflating ducts in systems without a soft start, otherwise known as "duct pop".



Taut Endcaps with plastic strip glided in place.



Plastic strip is easily glided in dedicated sleeve.

Taut Endcap

In certain applications, the visual appearance of the air distribution system is very important, that is why FabricAir designed a Taut Endcap that provides a smooth endcap and aesthetically pleasing appearance regardless if the system is on or off. The Taut Endcap is available for diameters between Ø300 mm [Ø12 in] to Ø1000 mm [Ø40 in]. This appealing solution is being created by a specifically designed plastic strip that you can easily glide in place when installing the system, or simply remove for the laundry process.

Supported suspension types: 01, 03, 05, 07, 08.



Internal 360° hoops



All-in-One



Internal 360° Hoops can be removed at the 6 o'clock position

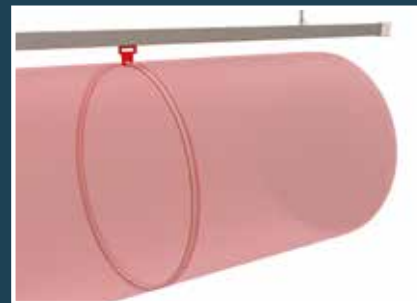

Internal 360° Hoops added to a Type 8 suspension in an internal sleeve



All-in-One Support added to a Type 8 suspension in an external pocket

Internal 360° Hoops

The Internal 360° Hoops are mounted in sleeves on the inside of the ductwork creating a closed circuit around the circumference. This ensures an aesthetically pleasing duct that is kept open if the airflow is turned off. The hoops are removable for easy laundry. Internal 360° Hoops are available in duct systems from $\text{Ø}200$ mm [$\text{Ø}8$ in] and up. The hoops come pre-installed from the factory on ducts up to $\text{Ø}660$ mm [$\text{Ø}26$ in]. For diameters above $\text{Ø}660$ mm [$\text{Ø}26$ in], the suspension fiberglass rods are added on site. Adding the hoops is an easy process, as they simply glide in place.

All-in-One Support

All-in-One Support (AiO) consists of semi-circular hangers, made from anodized aluminum, sewn into pockets on the exterior of the duct at fixed intervals. These come pre-installed from the factory, which significantly reduces installation time compared to the systems offered by other manufacturers. The All-in-One Support is easily removable for maintenance purposes. The appropriate suspension support depends on the diameter of the duct. The AiO Support will cover 180° of the duct's circumference up to $\text{Ø}1220$ mm [$\text{Ø}48$ in]. For diameters above $\text{Ø}1220$ mm [$\text{Ø}48$ in], hanger coverage decreases due to shipping constraints. All-in-One provides additional support for 90° elbows.

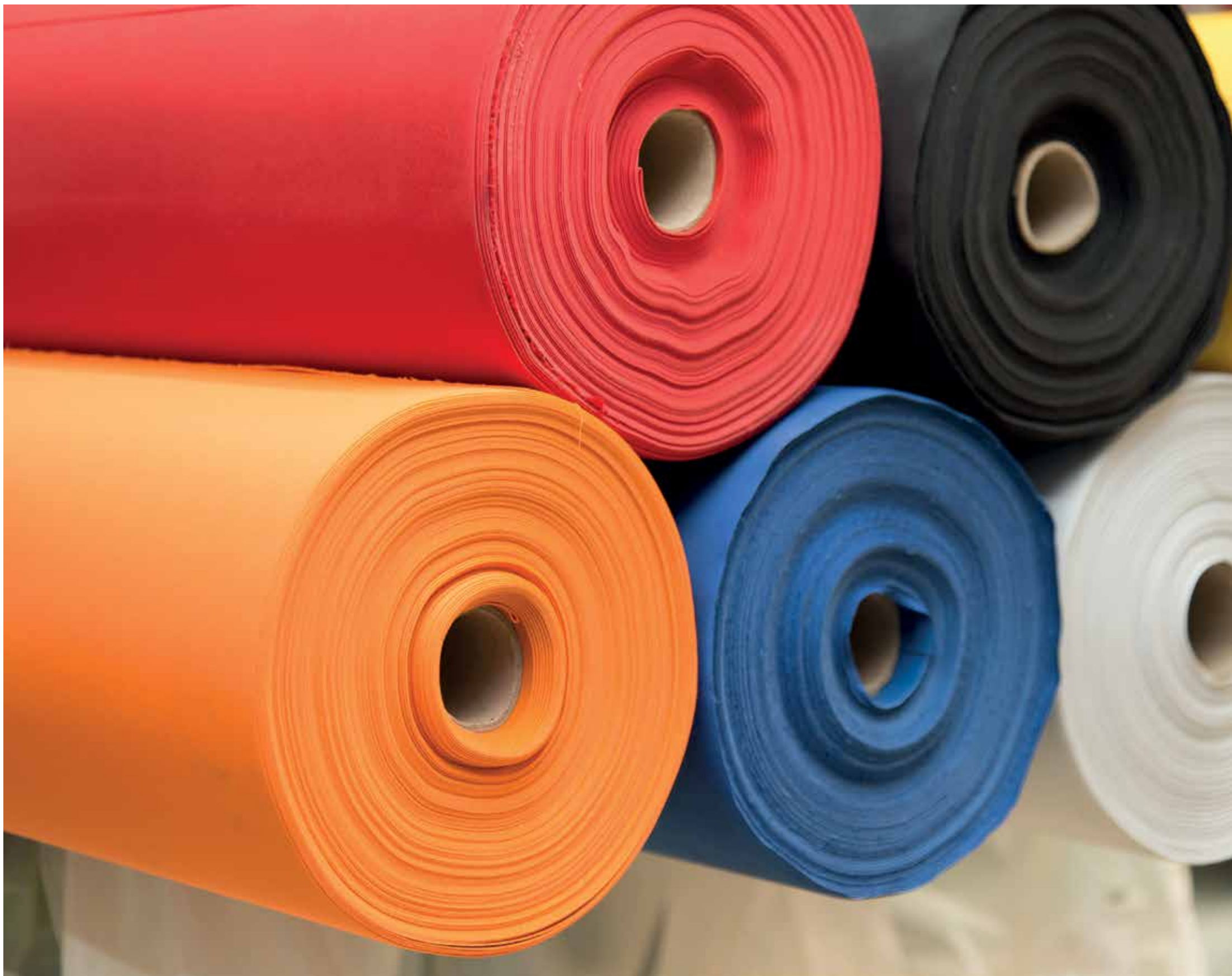



FABRICS

The ideal fabric properties depend on the specific application: swimming pools require permeable fabric to prevent condensation; food processing may require anti-microbial fabric; a high school gym may require a custom color or logo print to match the school's colors.

FabricAir® Dispersion Systems are custom engineered to create the ideal fit for each application's specific requirements.

Options include anti-static, flame retardant, permanently flame retardant, non-combustible, impermeable, varying permeabilities and anti-microbial.

For non-standard fabrics please contact your local FabricAir® office. Contact information is found on the back of this brochure.

Permeable Fabrics

Permeable fabrics eliminate condensation on the duct surface by creating an air blanket surrounding the duct.

These are ideal in humid spaces, such as food processing facilities or swimming pools, where there is a high probability of condensation.

Non-permeable Fabrics

Non-permeable fabrics are airtight. The air is distributed solely through the flow model.

These ducts are typically made out of coated materials.

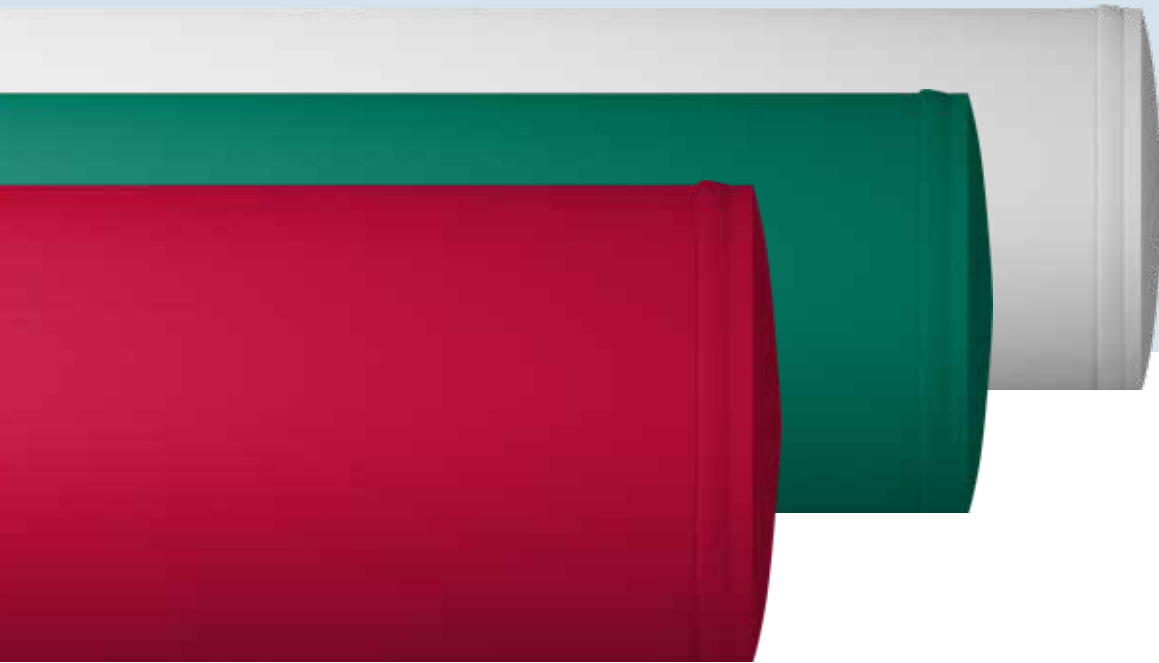

FabricAir® Combi











FabricAir® Combi is available as permeable, non-permeable and flame retardant fabrics. All fabric variants are exceptionally strong and durable and come with 5- or 10-year warranties.

FabricAir® Combi is Oeko-Tex 100 certified. The fabric is machine washable and retains its dimensions after washing (max. 0.5% shrinkage). The permeability is uniform (max. 5% variation).

FabricAir® Combi 80 and Combi 90 are supplied with an anti-microbial treatment, which is specially developed for areas with strict hygiene requirements.

The fabric is supplied in standard colors, with the option of surface print and other custom graphic prints.

| Fabric Type | Certificates | | | | | | | | | | | | Features | | | | | Flow Models | | | | | | |
|---------------------|--------------|---------------|------------|--------|------------|------------|--------|--------------|----------------|--------------|---------|----------|----------------|-------------|----------|------------|---------------------|-------------|------------|------------|------------|----------|-----------|----------|
| | Permeable | Non-permeable | EN 13501-1 | UL 723 | ULC s102.2 | NFP 92:507 | DS 428 | GB 8624 | EN ISO 14644-1 | Oeko-Tex 100 | UL 2518 | Warranty | Anti-microbial | Anti-static | Washable | All-in-One | Internal 360° Hoops | FabFlow™ | MicroFlow™ | PerfoFlow™ | SonicFlow™ | OriFlow™ | NozzFlow™ | JetFlow™ |
| FabricAir® Combi 20 | ✓ | | B-s1,d0 | ✓ | ✓ | M1 | ✓ | B-s1, d0, t1 | class 3 | ✓ | ✓ | ⑤ | | | ✓ | ✓ | ✓ | ✓ | ✓ | ✓ | ✓ | ✓ | ✓ | ✓ |
| FabricAir® Combi 30 | | ✓ | B-s1,d0 | ✓ | | M1 | ✓ | B-s1, d0, t1 | class 3 | ✓ | ✓ | ⑤ | | | ✓ | ✓ | ✓ | | ✓ | ✓ | ✓ | ✓ | ✓ | ✓ |
| FabricAir® Combi 60 | ✓ | | | | ✓ | | | B-s1, d0, t1 | class 3 | ✓ | | ⑩ | | | ✓ | ✓ | ✓ | ✓ | ✓ | ✓ | ✓ | ✓ | ✓ | ✓ |
| FabricAir® Combi 65 | | ✓ | | | | | | B-s1, d0, t1 | class 3 | ✓ | | ⑩ | | | ✓ | ✓ | ✓ | | ✓ | ✓ | ✓ | ✓ | ✓ | ✓ |
| FabricAir® Combi 70 | ✓ | | B-s1,d0 | ✓ | ✓ | M1 | ✓ | B-s1, d0, t1 | class 3 | ✓ | ✓ | ⑩ | | | ✓ | ✓ | ✓ | ✓ | ✓ | ✓ | ✓ | ✓ | ✓ | ✓ |
| FabricAir® Combi 80 | ✓ | | B-s1,d0 | ✓ | ✓ | M1 | ✓ | B-s1, d0, t1 | class 3 | ✓ | ✓ | ⑩ | ✓ | | ✓ | ✓ | ✓ | ✓ | ✓ | ✓ | ✓ | ✓ | ✓ | ✓ |
| FabricAir® Combi 85 | | ✓ | B-s1,d0 | ✓ | ✓ | M1 | ✓ | B-s1, d0, t1 | class 3 | ✓ | ✓ | ⑩ | | | ✓ | ✓ | ✓ | | ✓ | ✓ | ✓ | ✓ | ✓ | ✓ |
| FabricAir® Combi 90 | | ✓ | B-s1,d0 | ✓ | ✓ | M1 | ✓ | B-s1, d0, t1 | class 3 | ✓ | ✓ | ⑩ | ✓ | | ✓ | ✓ | ✓ | | ✓ | ✓ | ✓ | ✓ | ✓ | ✓ |

| Standard colors | | | | | | | | | Dye color | Surface print | | Graphic print | | |
|---|---|---|---|---|---|--|---|---|-----------|---|---|---------------|-------|-----------|
| White 3000 | Blue 3001 | Orange 3002 | Dark Gray 3003 | Black 3004 | Red 3005 | Light Gray 3006 | Green 3007 | Tan 3008 | Dye | FABRICAIR® COMBI 20, 30, 60, 65, 70, 80, 85, 90 | | Artwork | Logos | Lettering |
| | | | | | | | | | Dye | Coloring | Seamless patterns | | | |
|  |  |  |  |  |  |  |  |  | Dye |  |  | ✓ | ✓ | ✓ |

FABRICAIR® COMBI 20, 60, 70, 80

These four FabricAir® Combi variants are all permeable, Oeko-Tex 100 certified fabrics. The fabric is washable, strong and durable, and comes with a 5- or 10-year warranty. The primary differences between these fabrics lie in their fire retardancy certification, warranty and anti-microbial option – please see table for specifics.

FABRICAIR® COMBI 30, 65, 85, 90

These four FabricAir® Combi variants are all non-permeable, Oeko-Tex 100 certified fabrics, which means FabFlow™ is not an option. The fabric is washable, strong and durable, and comes with a 5- or 10-year warranty. The fabrics differ in their fire retardancy certification, warranty and anti-microbial option – please see table for specifics.



FabricAir[®] Lite





FabricAir[®] Lite is a lightweight non-permeable Oeko-Tex 100 certified fabric series that offers anti-microbial, flame retardant and anti-static options, making these fabric variants ideally suited in areas of strict hygiene. Due to the nature of the fabric, FabFlow™ and long directional throw models using nozzles or jets are not an option.

FabricAir[®] Lite fabrics are machine washable and retain their dimensions after washing (max. 0.5% shrinkage).

The fabric is available in standard colors.

All FabricAir[®] Lite variants come with a 3-year warranty.

| Fabric Type | | | Certificates | | | | | | | | | | Features | | | | | Flow Models | | | | | | |
|--------------------|-----------|---------------|--------------|--------|------------|------------|--------|--------------|----------------|--------------|---------|----------|----------------|-------------|----------|------------|---------------------|-------------|------------|------------|------------|----------|-----------|----------|
| | Permeable | Non-permeable | EN 13501-1 | UL 723 | ULC s102.2 | NFP 92:507 | DS 428 | GB 8624 | EN ISO 14644-1 | Oeko-Tex 100 | UL 2518 | Warranty | Anti-microbial | Anti-static | Washable | All-in-One | Internal 360° Hoops | FabFlow™ | MicroFlow™ | PerfoFlow™ | SonicFlow™ | OriFlow™ | NozzFlow™ | JetFlow™ |
| FabricAir® lite 5 | | ✓ | | | | | | class 3 | ✓ | | ③ | | | ✓ | | | | ✓ | ✓ | ✓ | ✓ | | | |
| FabricAir® lite 10 | | ✓ | B-s1,d0 | | | | ✓ | B-s1, d0, t1 | class 3 | ✓ | | ③ | | | ✓ | | | | ✓ | ✓ | ✓ | ✓ | | |
| FabricAir® lite 15 | | ✓ | B-s1,d0 | | | | ✓ | B-s1, d0, t1 | class 3 | ✓ | | ③ | ✓ | | ✓ | | | | ✓ | ✓ | ✓ | ✓ | | |
| FabricAir® lite 20 | | ✓ | B-s1,d0 | | | | ✓ | B-s1, d0, t1 | class 3 | ✓ | | ③ | ✓ | ✓ | ✓ | ✓ | ✓ | | ✓ | ✓ | ✓ | ✓ | | |

| Standard colors | | | | Dye color | Surface print | | Graphic print | | |
|---|---|---|---|-----------|-----------------|-------------------|---------------|-------|-----------|
| White 7500 | Blue 7501 | Gray 7503 | Black 7504 | Dye | FabricAir® Lite | | Artwork | Logos | Lettering |
| | | | | | Coloring | Seamless patterns | | | |
|  |  |  |  | - | - | - | - | - | - |

FABRICAIR® LITE 5

FabricAir® Lite 5 is a lightweight and durable fabric that comes with a 3-year warranty. This is the ideal choice in applications where cost-effectiveness outweighs other selection criteria and where flame retardancy is not an issue.

FABRICAIR® LITE 10

FabricAir® Lite 10 is a lightweight and durable fabric, which comes with a 3-year warranty and flame retardancy certification. This is well suited to applications where cost-effectiveness is as important as flame retardancy.





FABRICAIR® LITE 15

FabricAir® Lite 15 is a lightweight, flame retardant and durable fabric that comes with a 3-year warranty. A specially developed anti-microbial coating makes this fabric a good choice in applications with strict hygiene requirements.

FABRICAIR® LITE 20

FabricAir® Lite 20 is a lightweight, anti-static and durable fabric with flame retardancy certification. It comes with a 3-year warranty, as well as an anti-microbial coating. The anti-static nature of the fabric makes it ideal in applications with very strict requirements such as laboratories and server rooms.

| Fabric Type | Certificates | | | | | | | | | | Features | | | | | Flow Models | | | | | | | |
|----------------------|--------------|---------------|------------|--------|------------|------------|-------------|---------|----------------|--------------|----------|----------|----------------|-------------|----------|-------------|---------------------|----------|------------|------------|------------|----------|-----------|
| | Permeable | Non-permeable | EN 13501-1 | UL 723 | ULC s102.2 | NFP 92:507 | DS 428 | GB 8624 | EN ISO 14644-1 | Oeko-Tex 100 | UL 2518 | Warranty | Anti-microbial | Anti-static | Washable | All-in-One | Internal 360° Hoops | FabFlow™ | MicroFlow™ | PerfoFlow™ | SonicFlow™ | OriFlow™ | NozzFlow™ |
| FabricAir® Glass 220 | ✓ | | ✓ | | M0 | | A2-s1,d0,t1 | | | | ① | | | | | | | ✓ | ✓ | ✓ | ✓ | | |

| Standard colors | | | | Dye color | Surface print | | Graphic print | | |
|---|---|---|---|-----------|----------------------|-------------------|---------------|-------|-----------|
| White 4000 | Blue 4001 | Gray 4002 | Black 4004 | Dye | FabricAir® Glass 220 | | Artwork | Logos | Lettering |
| | | | | | Coloring | Seamless patterns | | | |
|  |  |  |  | - | - | - | - | - | - |



FabricAir® Glass 220

FabricAir® Glass 220 is woven with non-combustible glass fibers, class M0 / A2, making it ideal in areas with strict fire rating requirements. The working temperature range goes from -40°C to +200°C [-40°F to 392°F]. The material cannot be machine washed.

The fabric is available in standard colors.

All FabricAir® Glass 220 variants come with a 1-year warranty.

| Fabric Type | Certificates | | | | | | | | | | | Features | | | | | Flow Models | | | | | | | | |
|-----------------|--------------|---------------|------------|--------|------------|------------|--------|---------|----------------|--------------|---------|----------|----------------|-------------|----------|------------|---------------------|----------|------------|------------|------------|----------|-----------|----------|--|
| | Permeable | Non-permeable | EN 13501-1 | UL 723 | ULC s102.2 | NFP 92:507 | DS 428 | GB 8624 | EN ISO 14644-1 | Oeko-Tex 100 | UL 2518 | Warranty | Anti-microbial | Anti-static | Washable | All-in-One | Internal 360° Hoops | FabFlow™ | MicroFlow™ | PerfoFlow™ | SonicFlow™ | OriFlow™ | NozzFlow™ | JetFlow™ | |
| FabricAir® Poly | | ✓ | | | ✓ | | | | | | ① | | | | | | | | | | | | ✓ | | |

| Standard colors | Dye color | Surface print | | Graphic print | | |
|---|-----------|-----------------|-------------------|---------------|-------|-----------|
| White 5200 | Dye | FabricAir® Poly | | Artwork | Logos | Lettering |
| | | Coloring | Seamless patterns | | | |
|  | - | - | - | - | - | - |

FabricAir® Poly

FabricAir® Poly is a cost-effective, non-permeable fabric available in white only. It is ideal in heavy industrial applications for distributing isothermal or heated air via OriFlow™.

FabricAir® Poly comes with a 1-year warranty.





Goodbye Standard – Hello Artful Ducting

Make your ductwork stand out with colorful patterns customized to the interior design scheme. Choose from our in-house selection or provide your own unique seamless patterns.

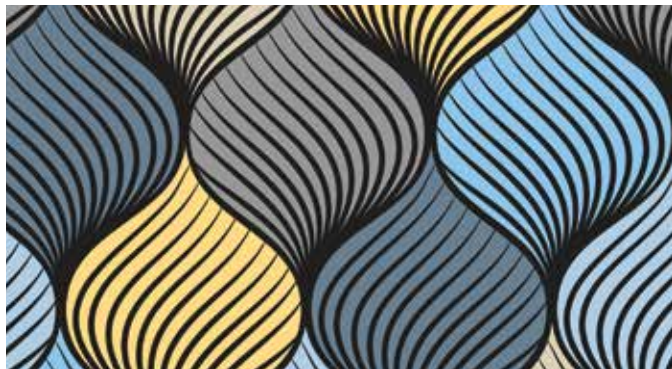

Look up for a colorful change

When deciding on a surface print custom color, please request the latest edition of the color swatch (surface print color card) from your local FabricAir office. To ensure the best results, it is important that your order contains the current color code from the color swatch.



Custom color print



Custom color print



Custom color DYE



Colors and Patterns: Custom colors, special dyes & surface print

FabricAir® ducts are available in a variety of standard colors using dyed fabrics or dyed yarns. Surface printing technology is available for colors and patterns with FabricAir® Combi fabrics.

Surface printing is a technique used to create custom colored ducts or ducts with seamless patterns from white fabrics. Contrary to special dyes, the surface print technology is used to apply custom color or patterns to the surface of the duct. The inside of the duct remains white, which in some instances may be seen through large perforations, orifices or nozzles.

Seamless patterns add a decorative element to the ductwork. They require specially adapted designs or motifs to ensure seamless repeatability and applicability, as they cover the entire circumference of the duct.

Nozzles, sliders and hooks come in red, blue, white, black, orange or gray. The standard color combinations can be altered upon request within the available color schemes.





Artwork, Logos & Lettering

Logos and lettering on ducts can be used to brand your company or send specific messages. It is created using heat transfer. The print placement is determined by the duct's location in the room and the typical positioning of the onlooker. For example, in sports facilities, the print is angled downward to make it look natural to the spectators.

There is no limitation on the logo types or colors, and the print will not fade over time or in case of washing.



BRANDED DUCTWORK

Use your ductwork to send messages or brand your company toward employees, visitors or facility users. Adding logos, lettering or artwork personalizes your air dispersion solution.

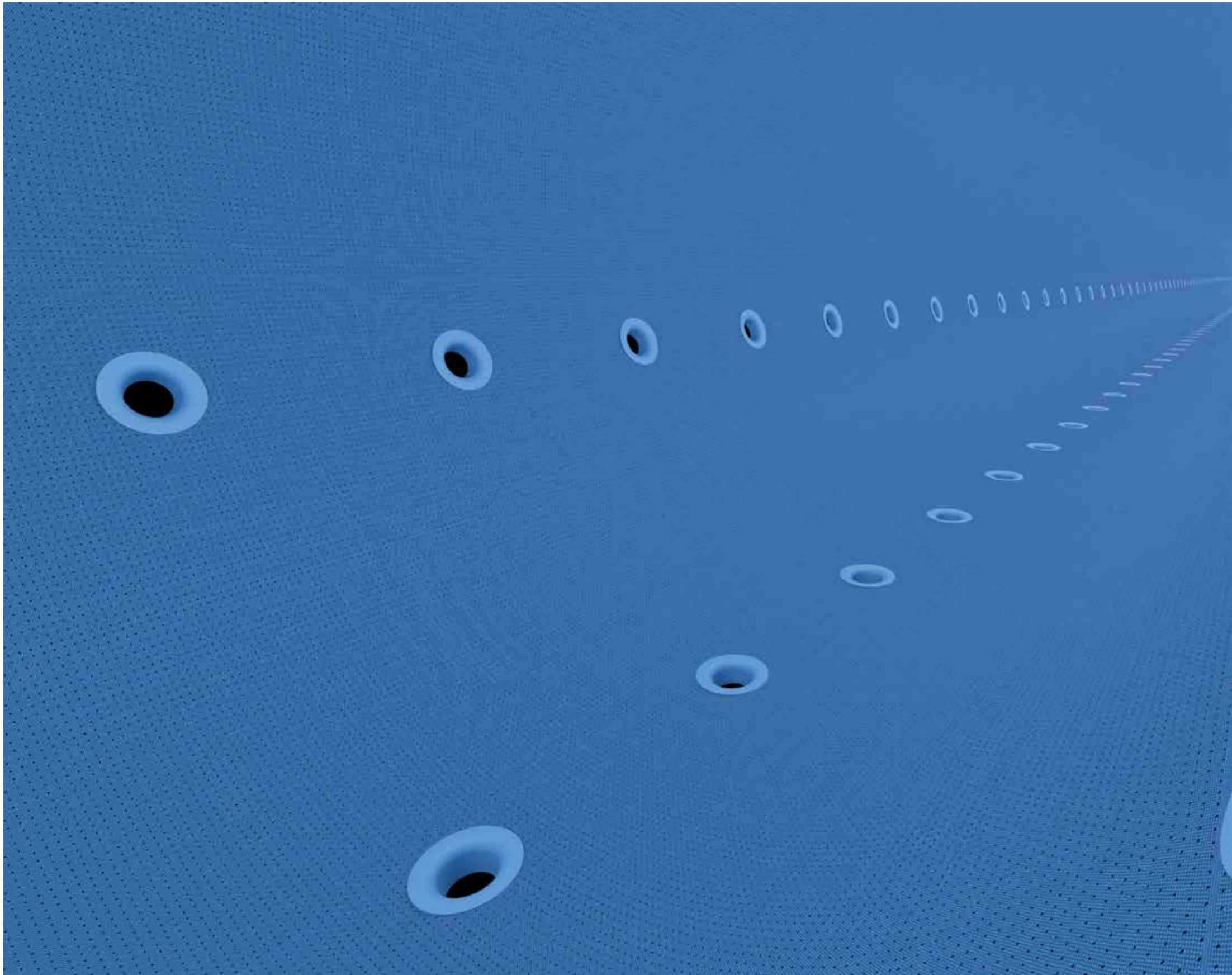

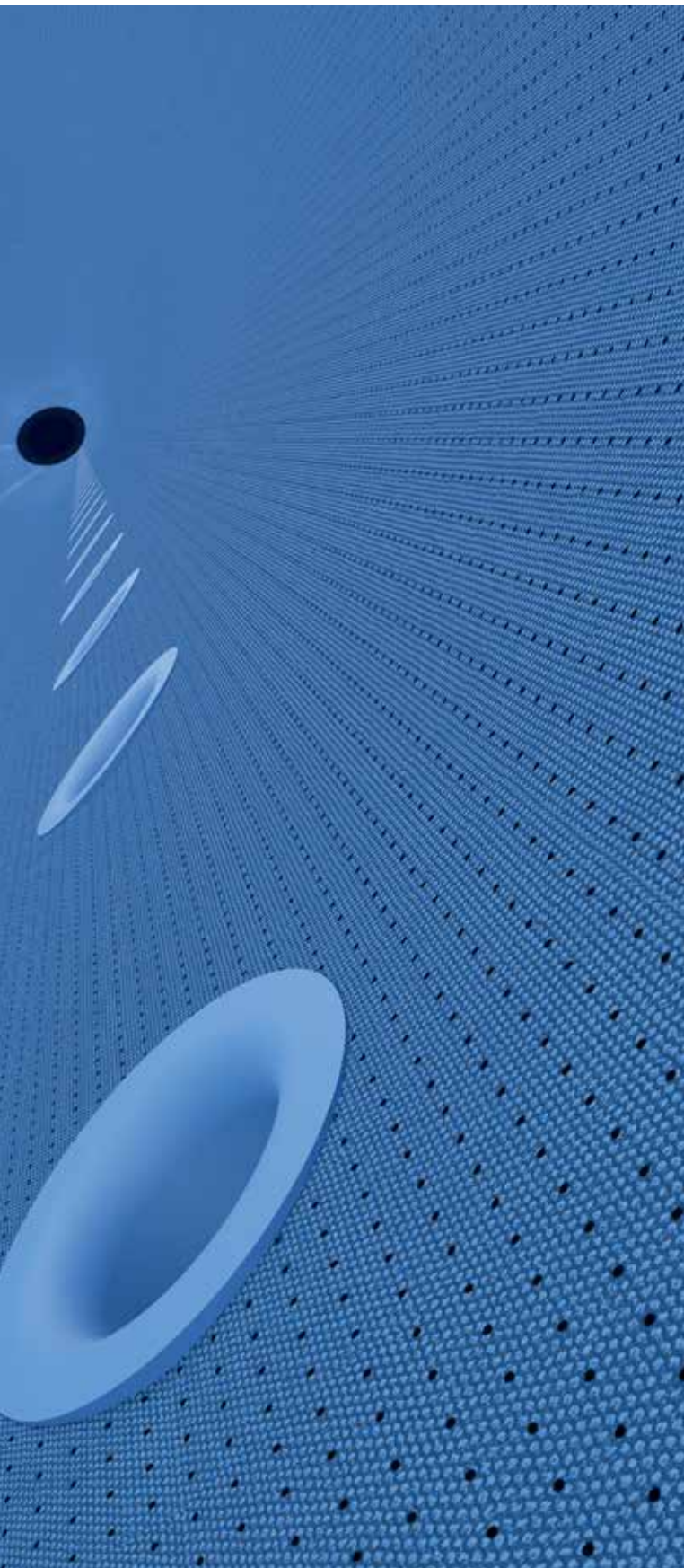

FLOW MODELS

FabricAir® offers a wide variety of flow models that can be combined to create the ideal air distribution, addressing any specific project challenges.

The ideal air dispersion often consists of primary and secondary airflows in combination, depending on throw requirements. The primary airflow addresses the main issue, whereas the secondary airflow is used to ensure that no condensation builds up on the duct in humid environments.

It is of utmost importance to understand the type of space that is being conditioned in order to select the appropriate flow models, especially in applications that are intended to maximize occupant comfort.

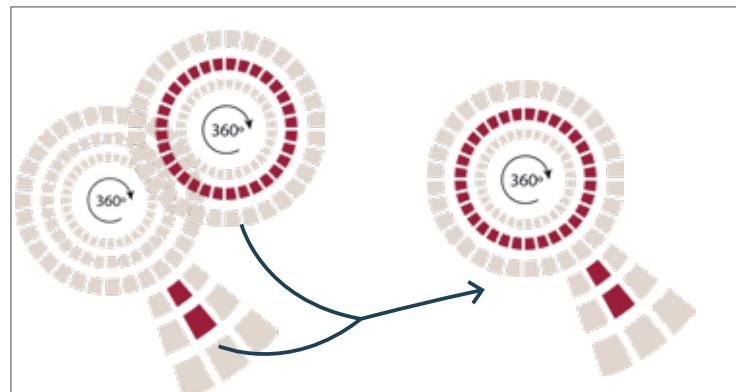

COMBINING FLOW MODELS

By combining flow models the ideal airflow is achieved regardless of the project complexity.

Surface and Directional Flow Models

SURFACE TECHNOLOGY





Surface flow models distribute the air through the surface of the duct either through permeable fabrics or perforations covering a minimum of 25% of the surface. These flow models are often used as primary flow or as secondary flow in combination with a directional flow model.

Perforations may cover between 25% to 100% of the duct's surface area. Surface flow technology is often used to prevent dust and other particles from accumulating inside or on the duct's surface, making it virtually maintenance-free. Surface technology also prevents condensation from forming in or around the duct's near zone.

DIRECTIONAL TECHNOLOGY

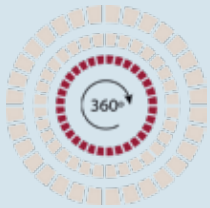
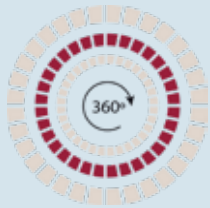
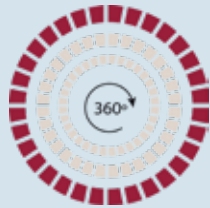
Directional flow models will have a row or more of air distribution placed along the length of the duct at any desired position to deliver the air exactly where it is needed.

Directional technology is typically used for the primary airflow and comprise flow models with low, medium and long throws. The flow models can be combined as necessary to achieve the desired air distribution patterns.

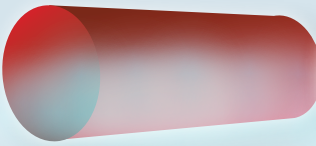
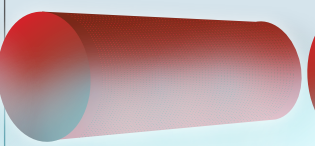
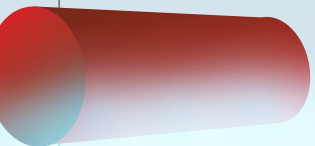
| Surface Flow Models | | | |
|---|---|---|--|
| FABFLOW™ | MICROFLOW™ | PERFOFLOW™ | |
|  |  |  | |
|  |  |  | |
| Permeable | Microperforations 0,2–0,6 mm [0,008–0,024 in] diameter | Perforations 3,0–14,0 mm [0,12–0,55 in] diameter | |
| Near-zone: Null (surface velocity below 0,5 m/s or [100 fpm]) | Near-zone: Maximum 300 mm [11.8 in] | Near-zone: up to 6,400 mm [21 ft] | |
| ✓ | ✓ | ✓ | |
| ✓ | ✓ | ✓ | |
| ✓ | ✓ | ✓ | |
| ✓ | ✓ | ✓ | |
| ✓ | ✓ | ✓ | |
|  |  |  | |

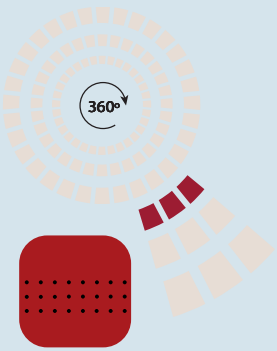
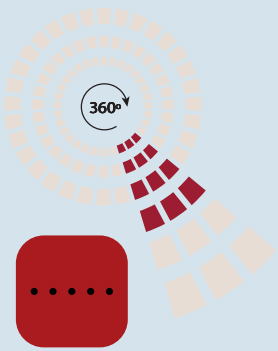
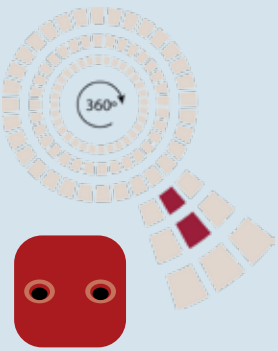
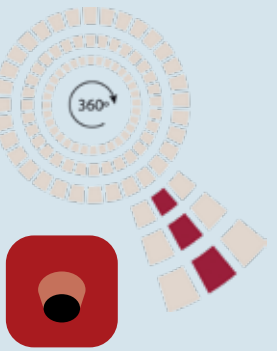
| Directional Flow Models | | | | |
|---|---|--|---|---|
| SONICFLOW™ | ORIFLOW™ | NOZZFLOW™ | JETFLOW™ | |
|  |  |  |  | |
| Perforations 3,0–14,0 mm [0.12–0.55 in] diameter | Orifices 14,1–125,0 mm [0.56–4.92 in] diameter | Nozzles 18,0 mm [0.71 in] diameter | Jets 50,0 to 250,0 mm [1.97–9.84 in] diameter | Flow Model Technology |
| 9,0–18,0 m/s [1.772–3.543 fpm] | 9,0–18,0 m/s [1.772–3.543 fpm] | 9,0–30,0 m/s, and more [1.772–5.905 fpm, and more] | 9,0–30,0 m/s, and more [1.772–5.905 fpm, and more] | Exit Velocity (or near-zone) |
| Medium/directional | High/directional | High/directional | High/directional | Throw |
| ✓ | ✓ | ✓ | ✓ | Round Profile |
| ✓ | ✓ | ✓ | ✓ | D-Shaped / Half-Round Profile |
| ✓ | ✓ | ✓ | ✓ | Circle Section Profile |
| ✓ | ✓ | ✓ | ✓ | Rectangular Profile |
| ✓ | ✓ | ✓ | ✓ | FabricAir® VarioDuct™ |

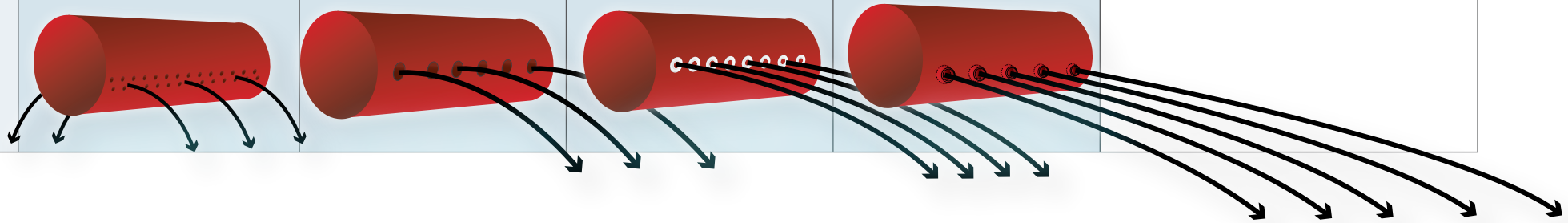

FabFlow™

In FabFlow™, the air exits the duct through the permeable fabric surface. The air is driven by thermodynamic forces, preventing drafts in the occupied zone. This results in a high level of comfort.

The density of the air drives the air dispersion. To ensure proper mixing without drafts the ΔT should not exceed 4°C [7.2 °F] when using FabFlow™ as the primary flow model.

As a secondary flow model it is often used to prevent condensation on the duct surface and/or dust from settling on the duct.

As a primary flow model, the typical applications are areas highly sensitive to drafts and for comfort ventilation. It is often found in working rooms in the food industry, laboratories, professional kitchens and offices, often with a low ceiling heights, and the air distribution is generated based on temperature differences only.

Air discharge through FabFlow™ of permeability 200 m³/h/m² [10 CFM/ft²] at 120 Pa [0.48 inwg]. Isothermal conditions.

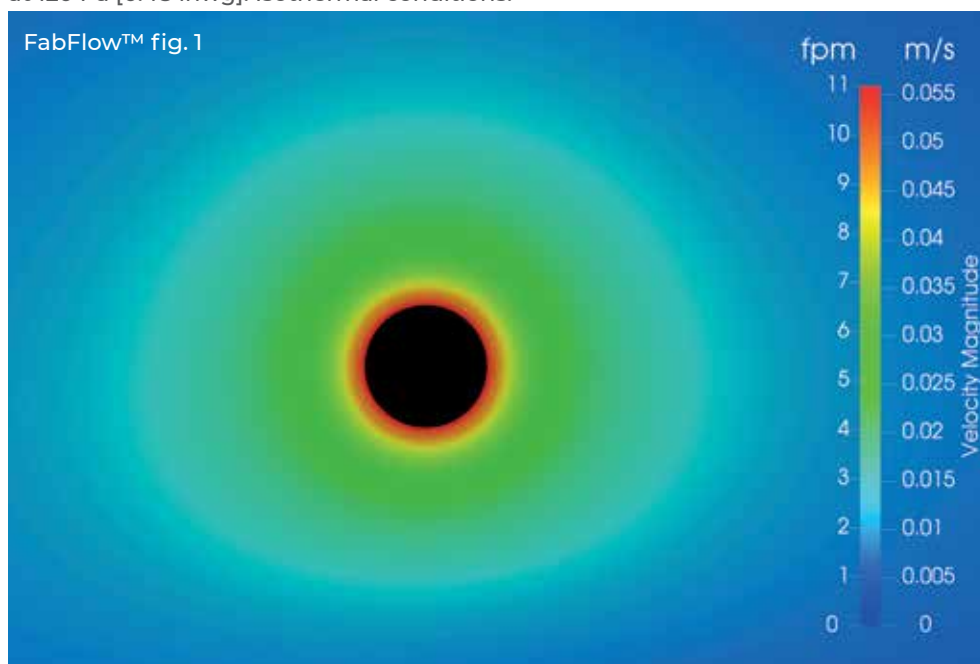

Examples of CFD simulations with FabFlow™ at 3 m [≈10 ft] above floor level. The occupied zone is indicated by the black line 1.8 m [≈6 ft] above floor level. Cold air exits the duct and moves downward due to thermodynamic forces. The gentle air diffusion accumulates and develops a uniform airflow as temperature difference increases. The airflow gains more momentum and the velocity increases with the distance from the duct.

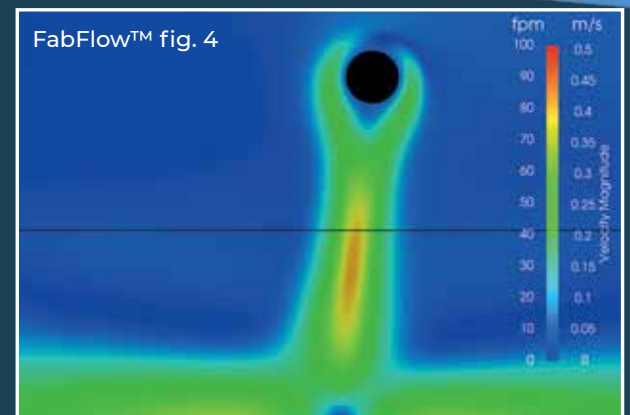
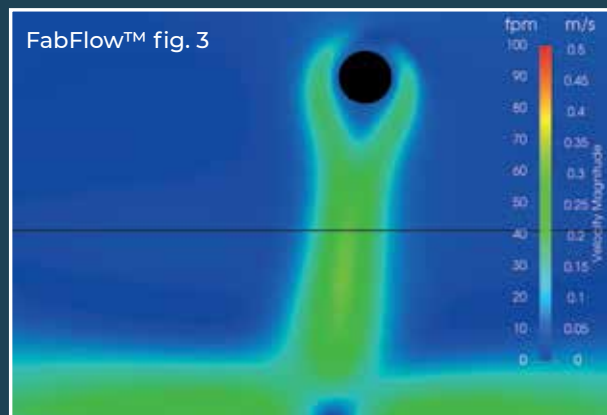
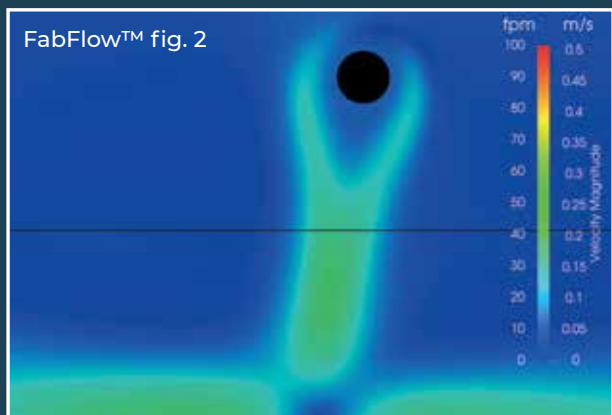
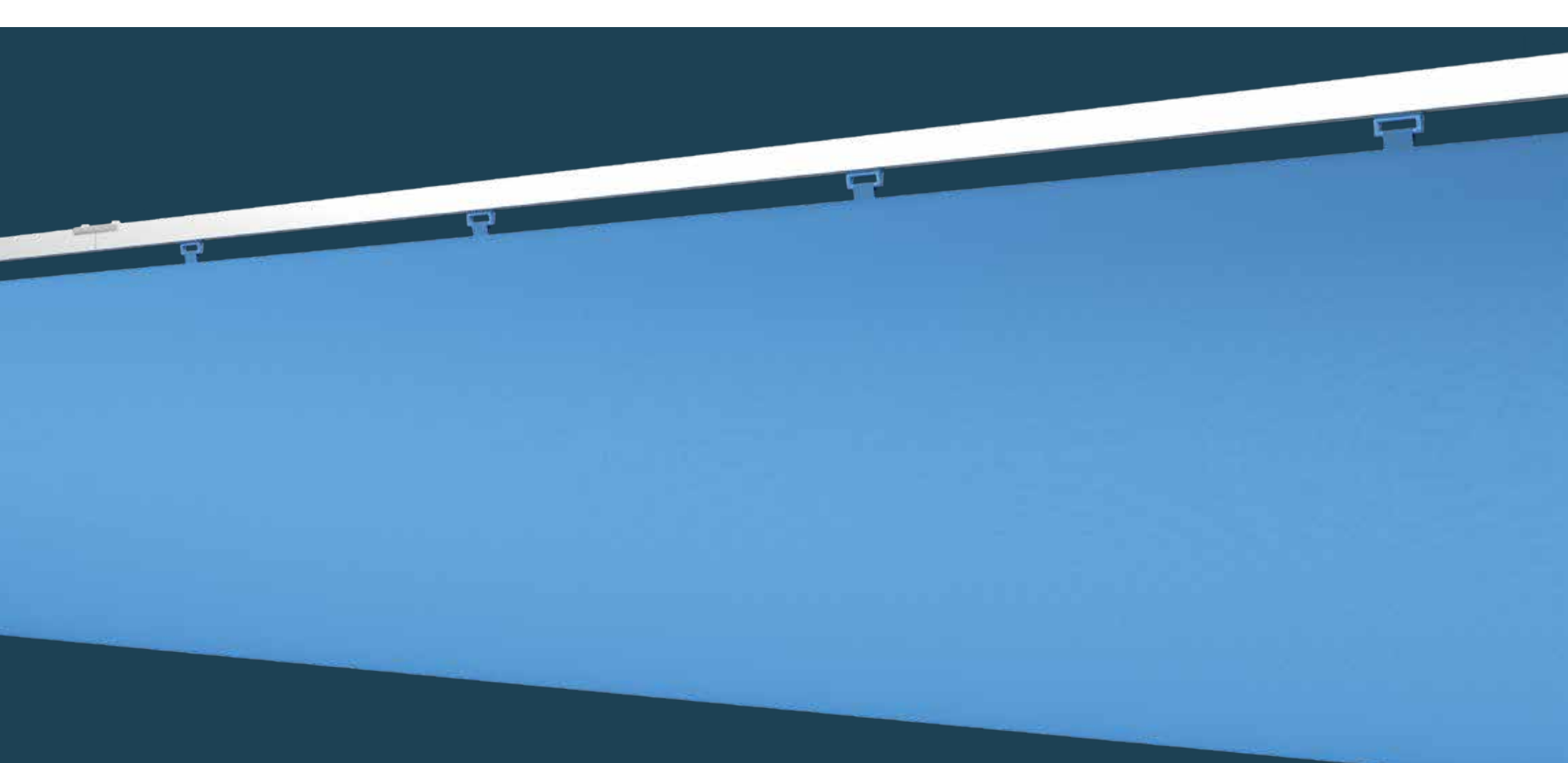

ΔT impact on air pattern

Air permeability 200 m³/h/m² [10 CFM/ft²] at 120 Pa [0.48 inwg], cooling with ΔT of -1 K [-1.8°F]. High level of comfort is achieved.

Air permeability 200 m³/h/m² [10 CFM/ft²] at 120 Pa [0.48 inwg], cooling with ΔT of -3 K [-5.4°F]. Increased cooling capacity and draft still avoided.

Air permeability 200 m³/h/m² [10 CFM/ft²] at 120 Pa [0.48 inwg], cooling with ΔT of -5 K [-9.0°F]. Micro-perforation enables a higher cooling capacity while keeping the occupied zone draft-free.

MicroFlow™

With MicroFlow™, the air exits the duct via laser-cut micro-perforations on a larger percentage of the duct's surface area. When used as the primary flow model, the perforated area covers between 25% to 100% of the duct's surface area.

MicroFlow™ has the smallest near-zone of all of the perforated fabrics available; the near-zone will not extend beyond 300 mm [≈12 in].

MicroFlow™ is used for thermal displacement with low velocity air dispersion in rooms with low to medium ceiling heights. The dispersed air falls slowly to the floor, shifting the hot air up and out, thus creating a pleasant and comfortable indoor environment in the occupied zone. Due to the extended near-zone, MicroFlow™ enables a larger ΔT than FabFlow™ without causing drafts.

As a primary flow model, the typical application is comfort ventilation where the ducts are placed relatively close to the occupied zone. It is often found in the food industry, offices, schools and the graphics and pharmaceutical industries.

Air discharge through MicroFlow™ of permeability $200 \text{ m}^3/\text{h}/\text{m}^2$ [10 CFM/ft²] at 120 Pa [0.48 inwg]. Isothermal conditions.

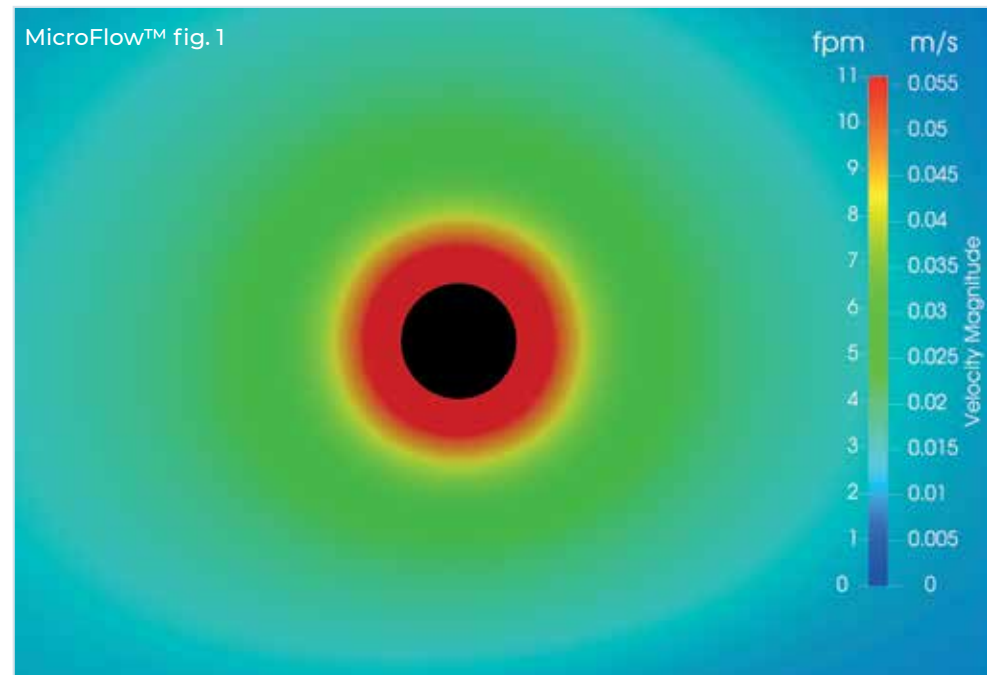

Examples of CFD simulations with MicroFlow™ at 3 m [≈10 ft] above floor level. The occupied zone is indicated by the black line 1,8 m [≈6 ft] above floor level. When the cold air exits the duct, it moves downward due to thermodynamic forces and merges into a uniform airflow that gains momentum as it moves away from the duct.



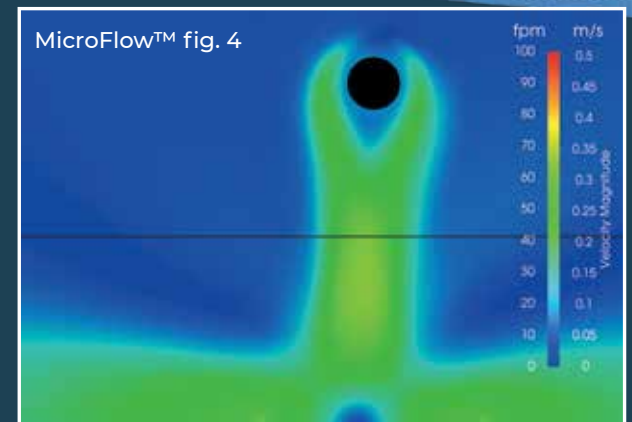
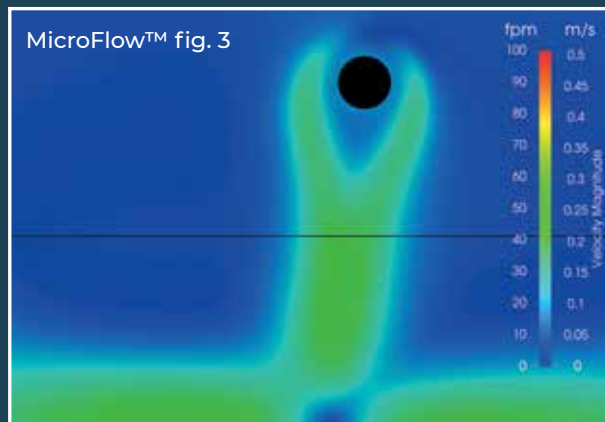
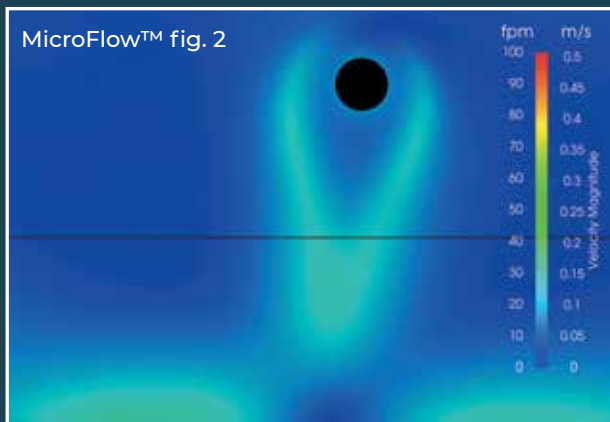
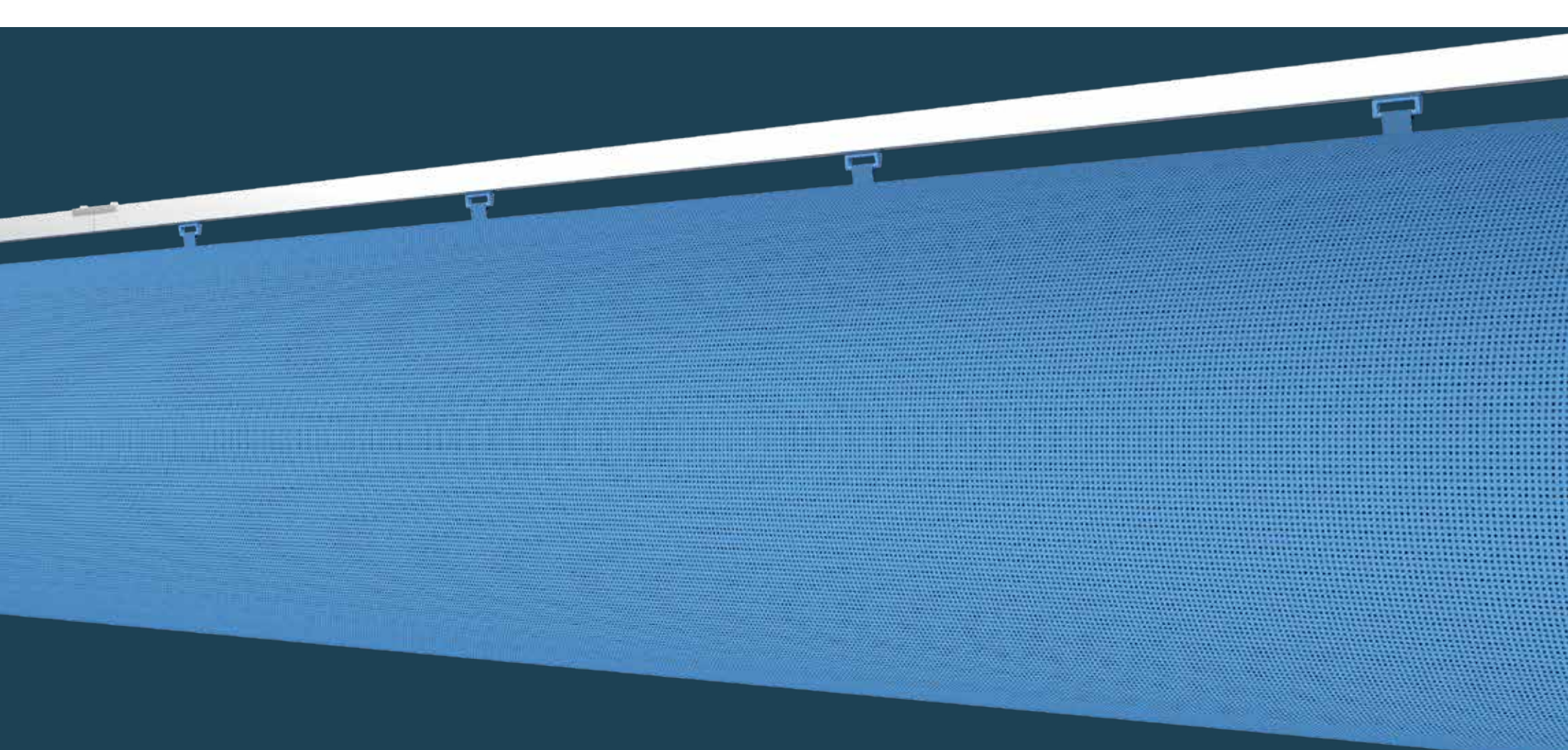

ΔT impact on air pattern - increased cooling capacity

Air permeability 200 m³/h/m² [10 CFM/ft²] at 120 Pa [0.48 inwg], cooling with ΔT of -1 K [-1.8°F]. High level of comfort is achieved.

Air permeability 200 m³/h/m² [10 CFM/ft²] at 120 Pa [0.48 inwg], cooling with ΔT of -3 K [-5.4°F]. Increased cooling capacity and draft still avoided.

Air permeability 200 m³/h/m² [10 CFM/ft²] at 120 Pa [0.48 inwg], cooling with ΔT of -5 K [-9.0°F]. Micro-perforation enables a higher cooling capacity while keeping the occupied zone draft-free.

PerfoFlow™

With PerfoFlow™, the air exits the duct via laser-cut perforations covering a larger percentage of the duct's surface area. When used as the primary flow model perforations cover between 25% to 100% of the total surface area.

The size of the near-zone depends on the static pressure inside the duct, the percentage of the surface that is perforated and the size and spacing of the perforations.

PerfoFlow™ enables distribution of large volumes of air in a non-specific direction; hence, high accuracy in the design phase is important. Careful engineering will ensure maximum efficiency without sacrificing the comfort of the workers.

As a primary flow model, it is typically used for make-up air in industrial applications with high ceiling heights and a need for large airflows to replace high levels of exhausted process air, such as painting and printing facilities, where air is extracted intensively to eliminate fumes and pollutants.

Air discharge through PerfoFlow™ perforation at 120 Pa [0.48 inwg].

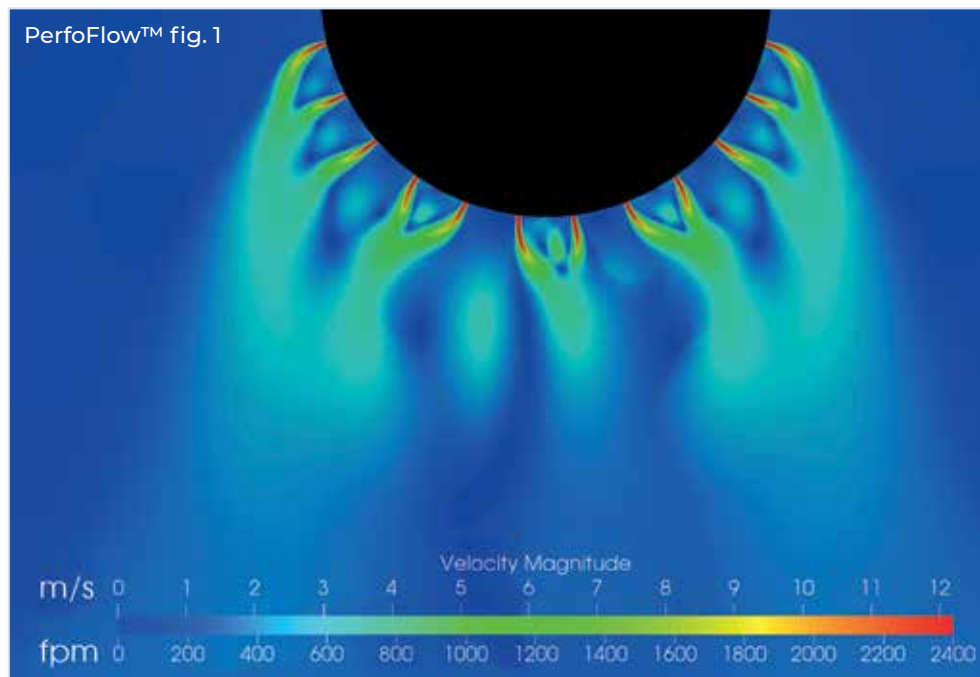

With PerfoFlow™, each perforation hole forms a separate air jet. As the air jets move away from the duct, they merge into confluent jets, which then merge together ultimately forming a uniform air diffusion. The resulting air diffusion will depend on many factors, including the size of holes and distance between them, perforation pattern and static pressure inside the duct.

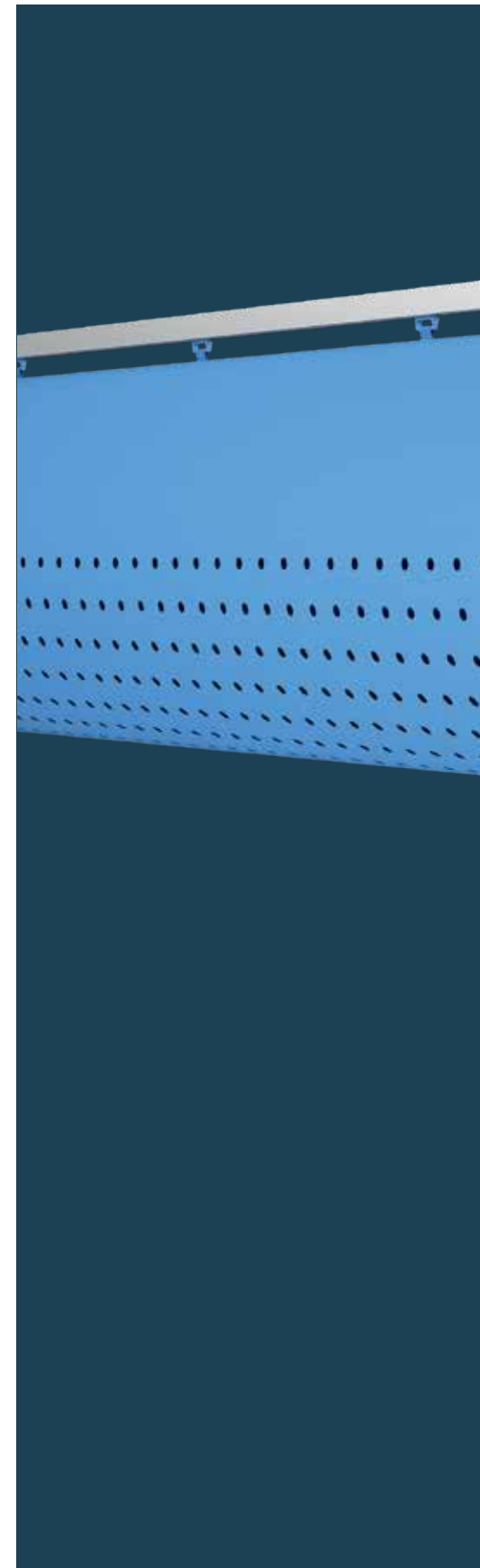

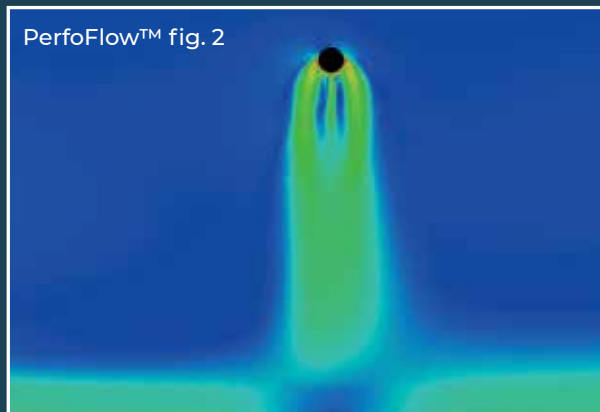
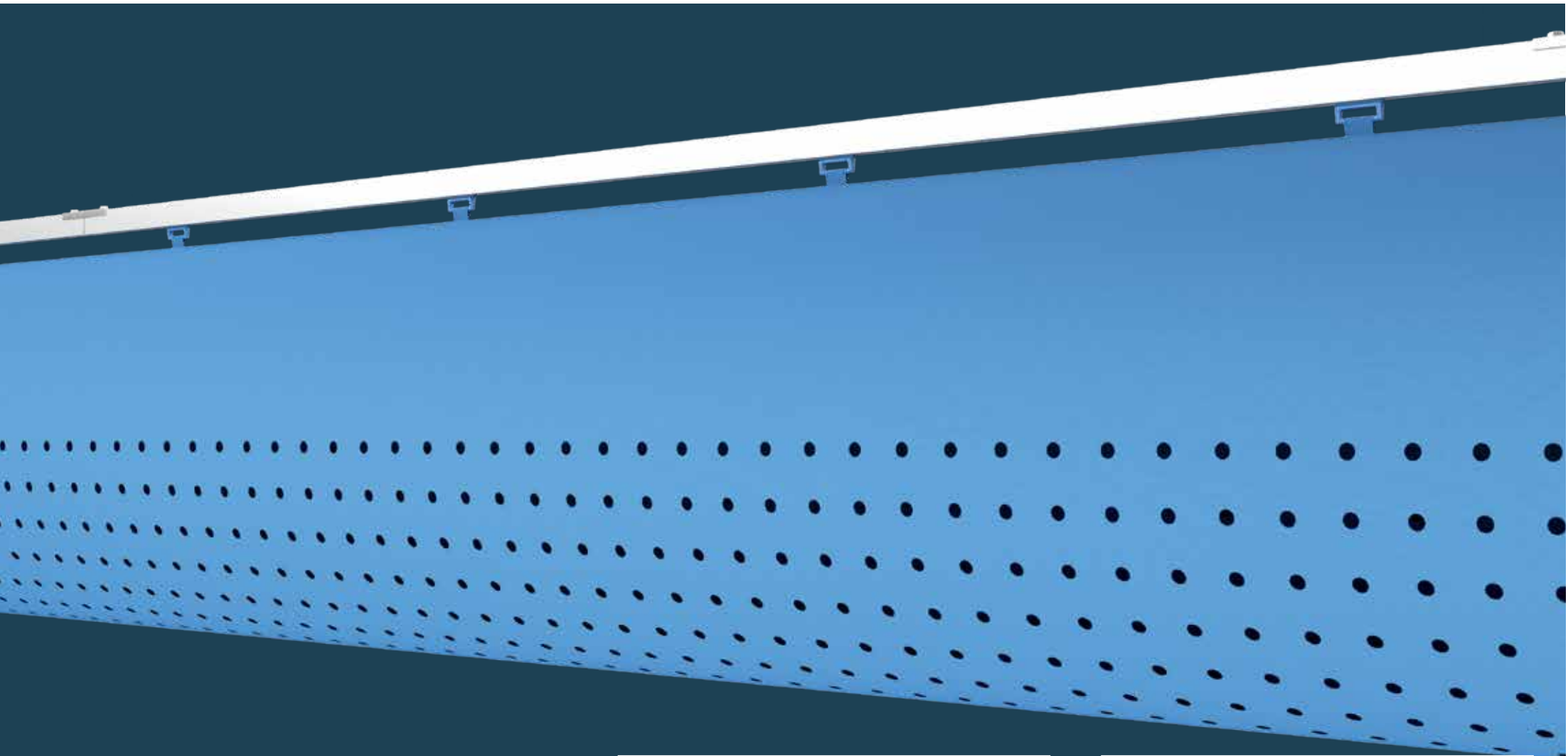

Perforation size impact on air pattern

Air diffusion with perforation of $\varnothing 5$ mm [≈ 0.2 in] holes located at 180° over 6 o'clock position. Cooling at ΔT of -6 K [-10.8°F].

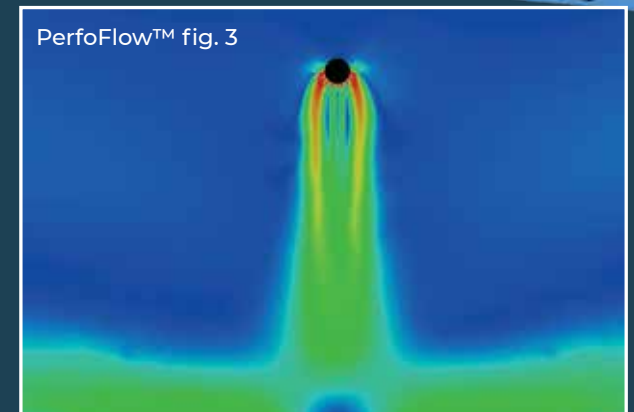

Air diffusion with perforation of $\varnothing 10$ mm [≈ 0.4 in] holes located at 180° over 6 o'clock position. Cooling at ΔT of -6 K [-10.8°F].

SonicFlow™

SonicFlow™ is a directional flow model where the air exits the duct via rows of laser-cut perforations.

Multiple rows of SonicFlow™ can be specified for a duct, with each row or number of rows pointing in a specific direction.

The throw depends on the static pressure inside the duct, the size of the orifices as well as the spacing of the orifices.

There are many different applications in which SonicFlow™ is ideal as the primary flow model. It is often used in retail or sports applications, where a medium ceiling height calls for directional throws to create proper induction without causing drafts.

Air discharge through SonicFlow™ orifice at 120 Pa [0.48 inwg].

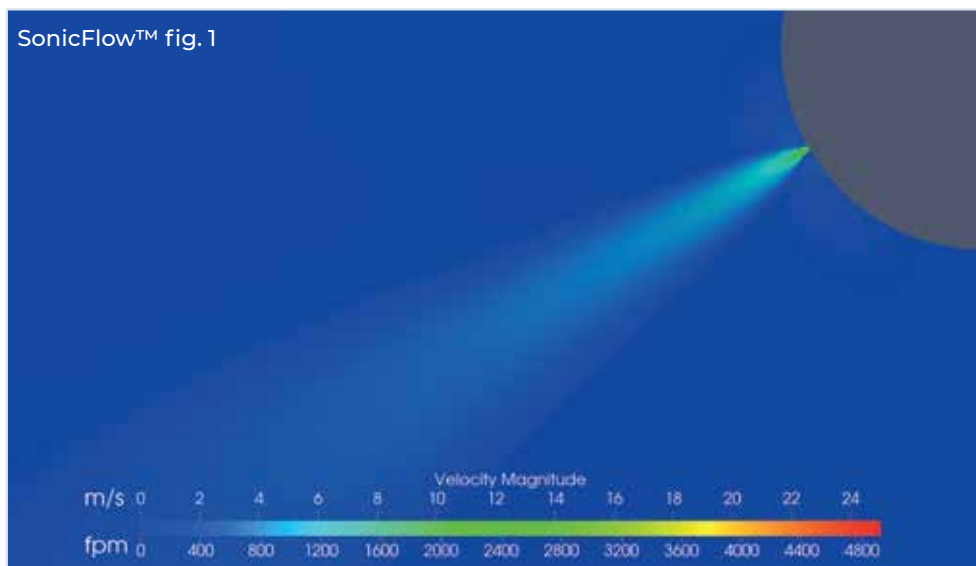

With SonicFlow™, the air exits at discharge velocity, which decreases with traveled distance from the duct and depends on the static pressure inside the duct. Fig. 2 shows an example of a CFD simulation with SonicFlow™ at 3 m [≈10 ft] above floor level. The occupied zone is indicated by the black line 1.8 m [≈6 ft] above floor level. Figs. 3 and 4 show the differences in airflow patterns between cooling and heating in scenarios with identical parameters.

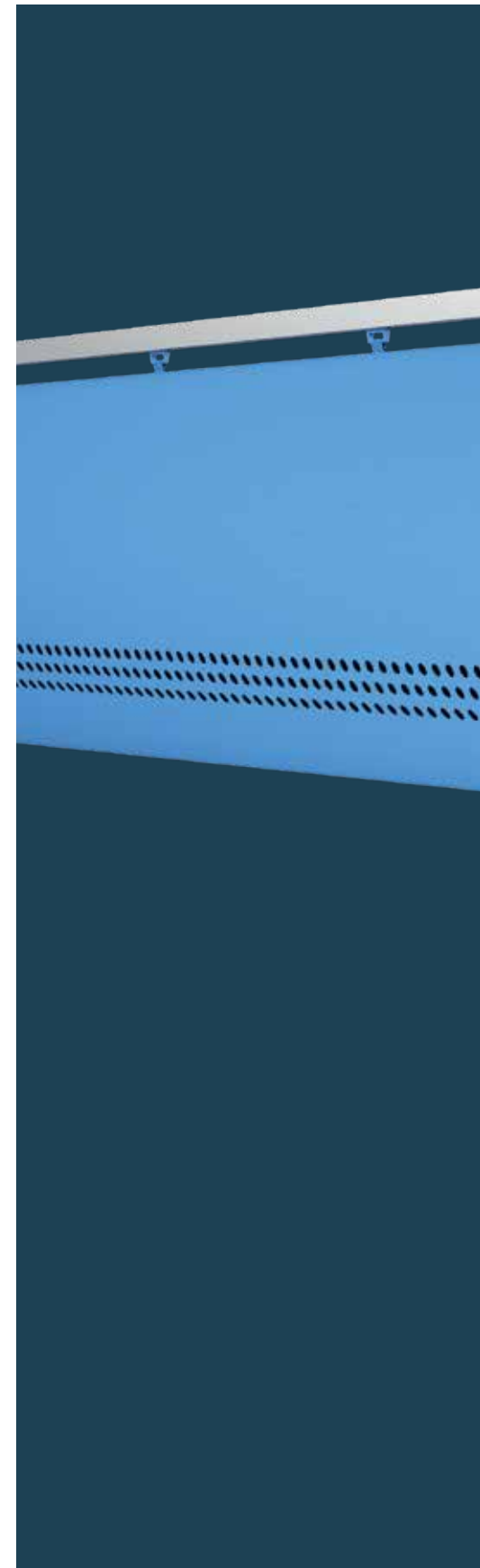

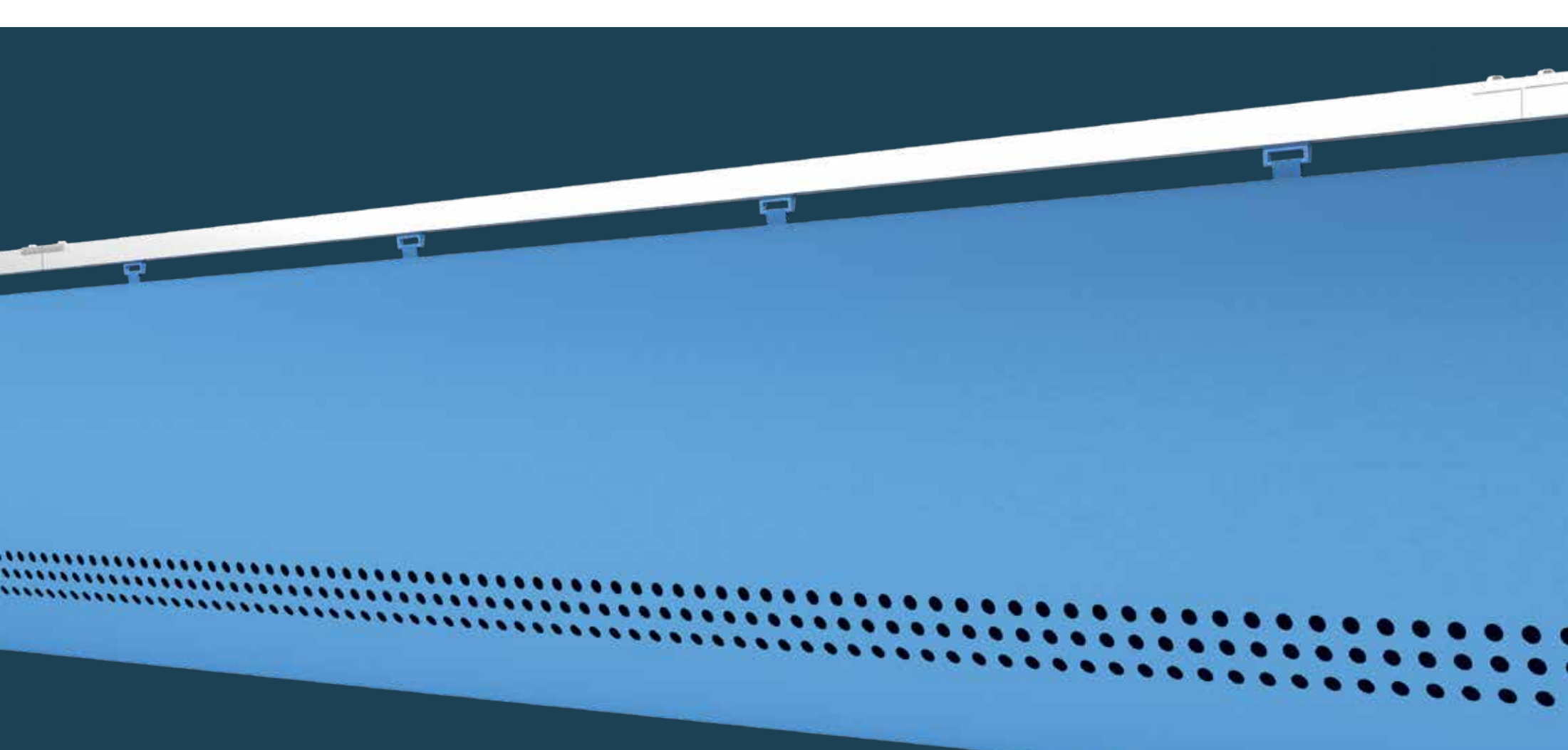

Example of Typical Application: Cooling at 3 m [≈ 10 ft], ΔT of -4 K [-7.2°F] and 120 Pa [0.48 inwg] static pressure. Air enters the occupied zone at required direction and velocity. The occupied zone is indicated by the black line 1.8 m [≈ 6 ft] above floor level.

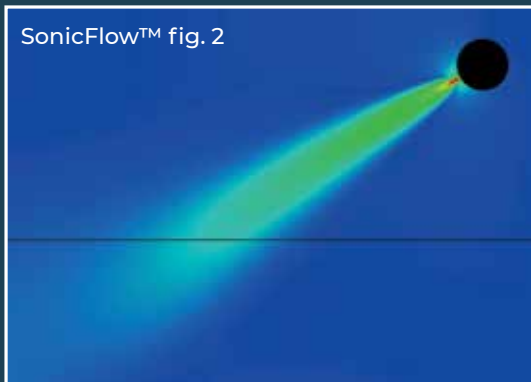

SonicFlow™ fig. 3

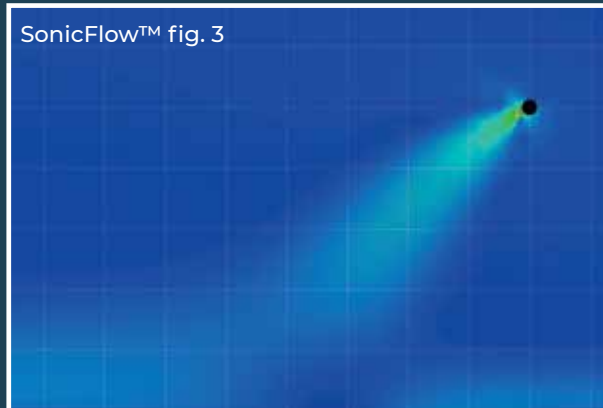

ΔT impact on air pattern

Air pattern in theoretical space: Impact of cooling at ΔT of -6 K [-10.8°F] and 120 Pa [0.48 inwg] static pressure.

SonicFlow™ fig. 4

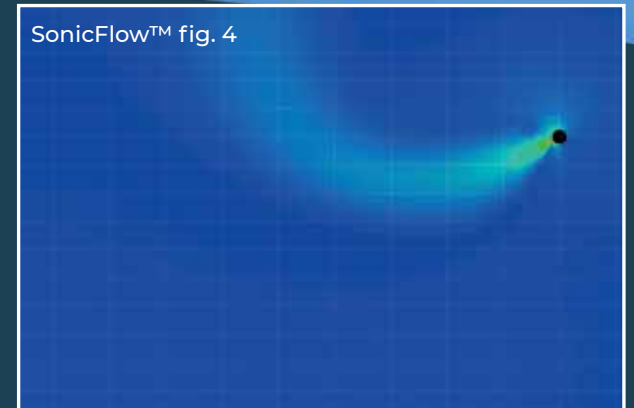

Example: Air pattern in heating with ΔT of $+6$ K [$+10.8^\circ\text{F}$] and 120 Pa [0.48 inwg] static pressure in a theoretical medium to large space.

OriFlow™

OriFlow™ is a directional flow model, where the air exits the duct via rows of laser-cut orifices. Multiple rows of OriFlow™ can be specified for a duct.

The throw depends on the static pressure inside the duct, the size of the orifices as well as the spacing of said orifices.

OriFlow™ is often used in applications where there is a need for directional air with a medium to high velocity to ensure proper mixing, but with lower requirements for precision. Typical applications include warehouses, distribution centers or industrial applications with higher ceiling heights.

Air discharge through OriFlow™ orifice at 120 Pa [0.48 inwg] static pressure.

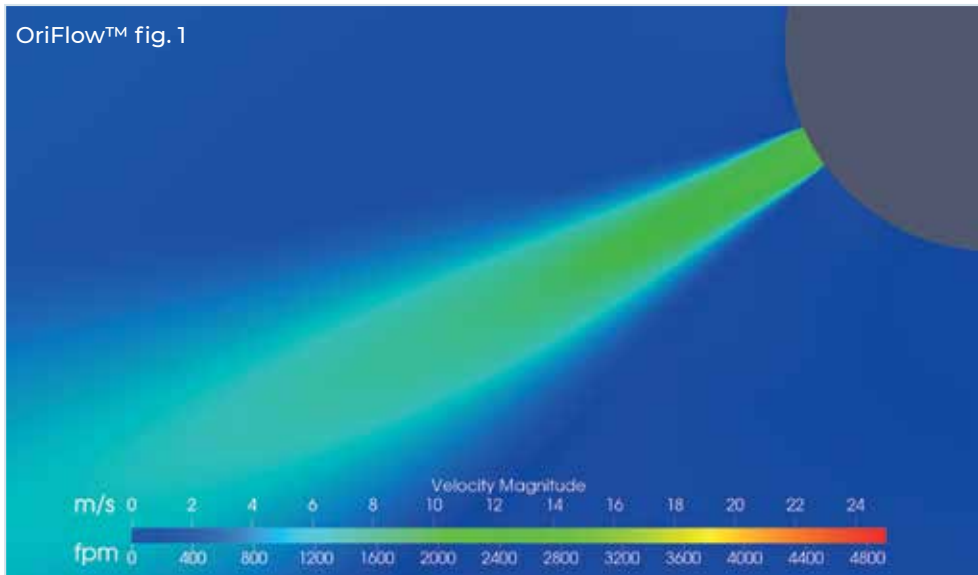

With OriFlow™, the air exits at discharge velocity, which decreases with traveled distance from the duct and depends on the static pressure inside the duct. With a properly designed air dispersion system, OriFlow™ is strong enough to ensure heating in medium to high installation projects.

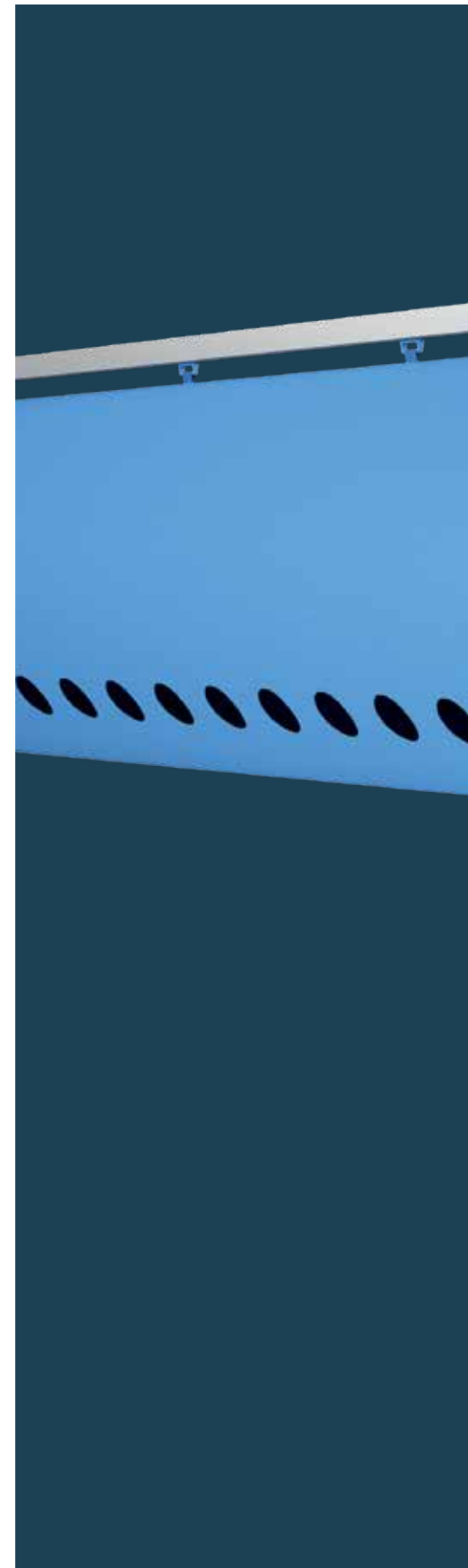

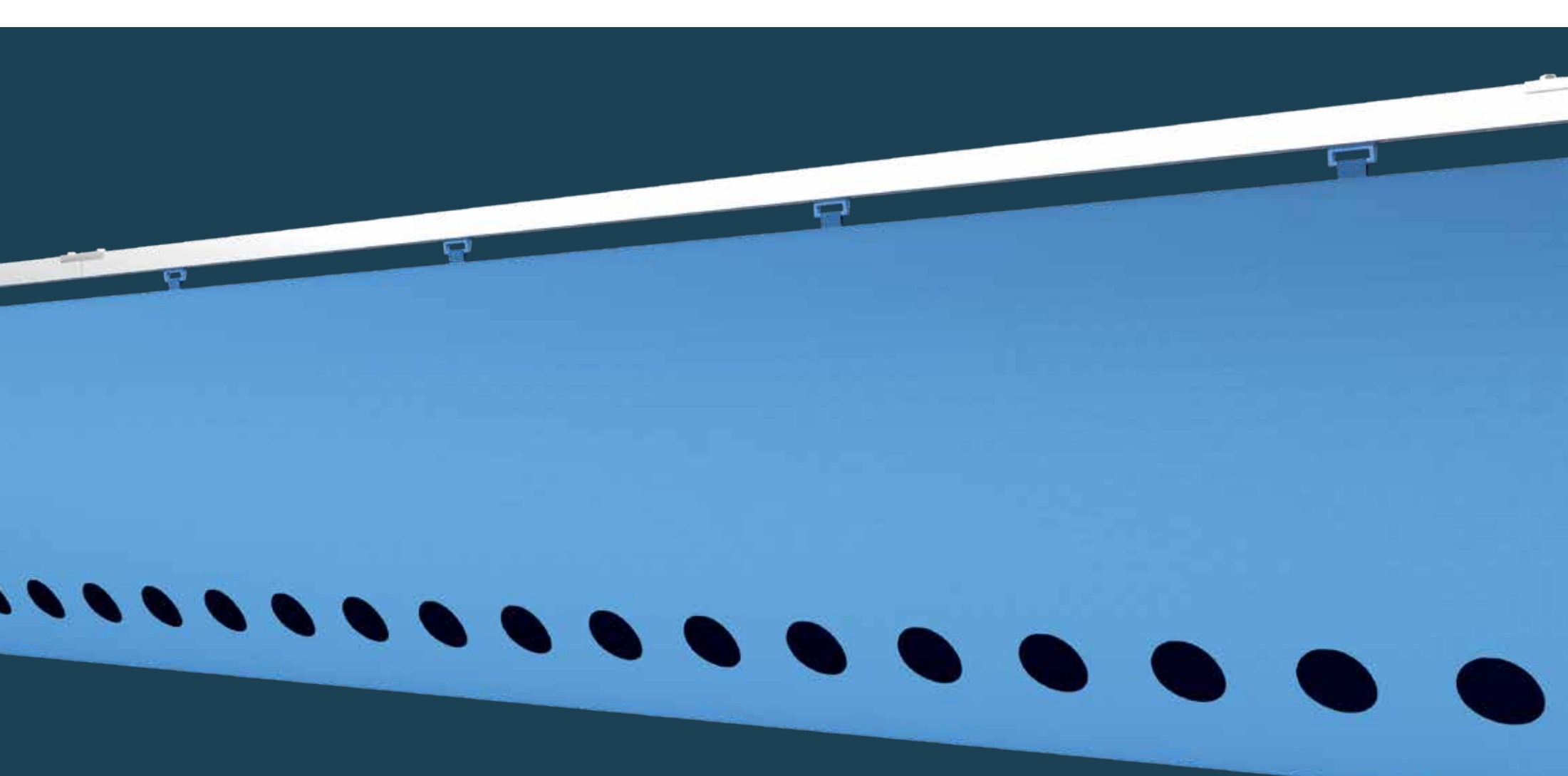

Example of Typical Application: Heating at 7 m [≈23 ft], ΔT of +10 K [+18°F] and 120 Pa [0.48 inwg] static pressure. Hot air reaches the occupied zone, regardless of high ΔT and installation height. The occupied zone is indicated by the black line 1.8 m [≈6 ft] above floor level.

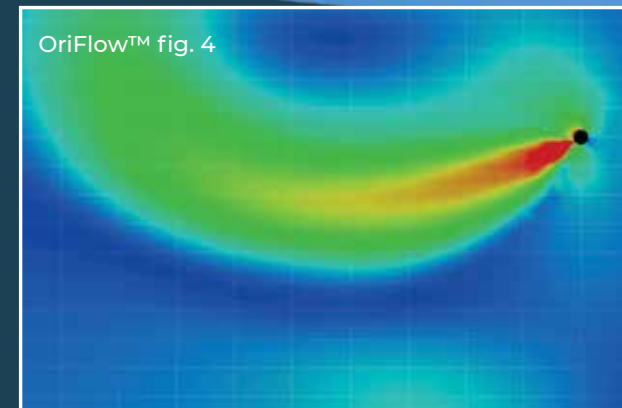
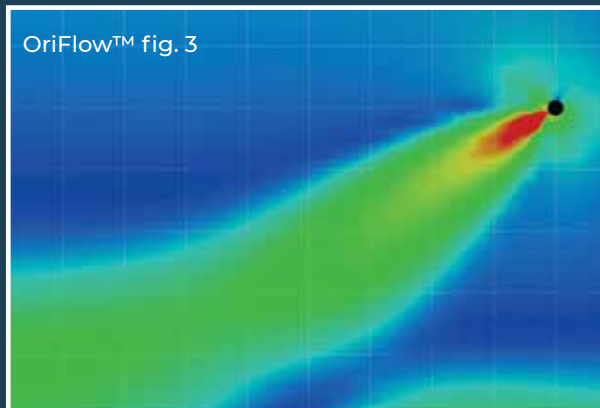
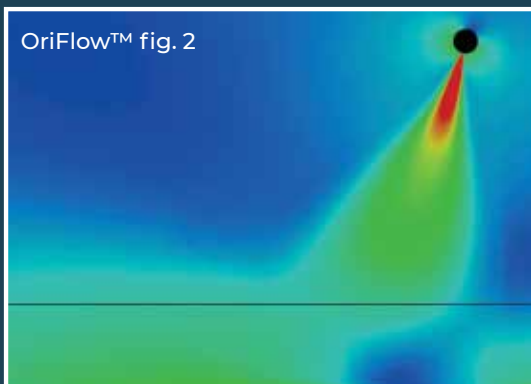

ΔT impact on air pattern

Example: Air pattern in cooling with ΔT of -6 K [-10.8°F] and 120 Pa [0.48 inwg] static pressure in a theoretical large space.

Example: Air pattern in heating with ΔT of +6 K [+10.8°F] and 120 Pa [0.48 inwg] static pressure in a theoretical large space.

NozzFlow™



NozzFlow™ is used in applications where a very precise directional airflow is needed.

The discharge coefficient is almost equal to 1, due to the conical shape of the nozzle. This also results in higher discharge velocities than equivalently sized orifices, and longer, more precise directional throws.

Typically, NozzFlow™ is used in applications where there is a need to distribute air precisely with a medium to high velocity, such as process air in industrial refrigeration projects, pools, or applications with warm air distribution. The conical nozzle has a high discharge coefficient and the perpendicular air supply makes the airflow very predictable even at longer throws.

Air discharge through NozzFlow™ nozzle at 120 Pa [0.48 inwg] static pressure.

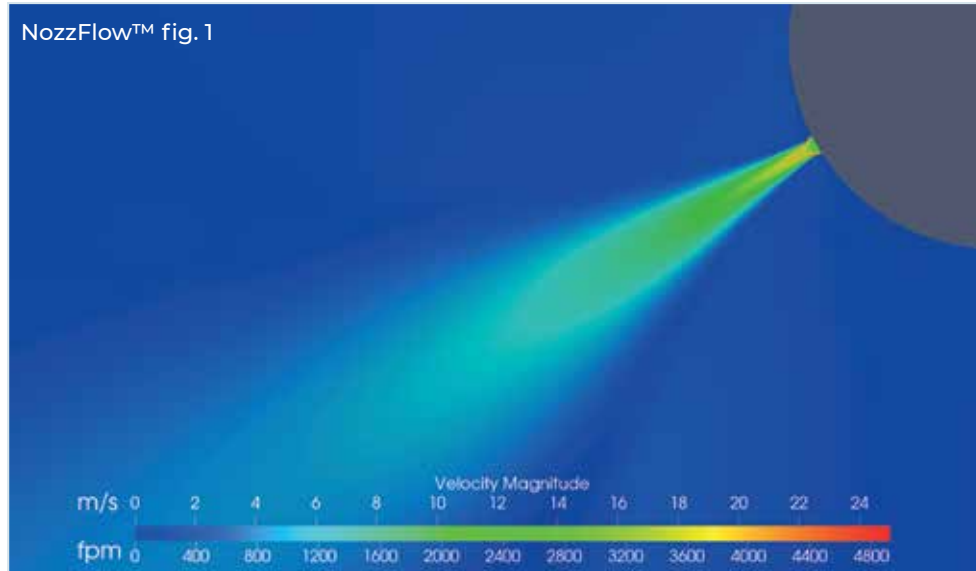

The flow is accelerated due to the conical shape of the nozzle. The acceleration rate depends on the static pressure inside the duct. The characteristics of NozzFlow™ makes it possible to precisely direct the air exactly where it is required.



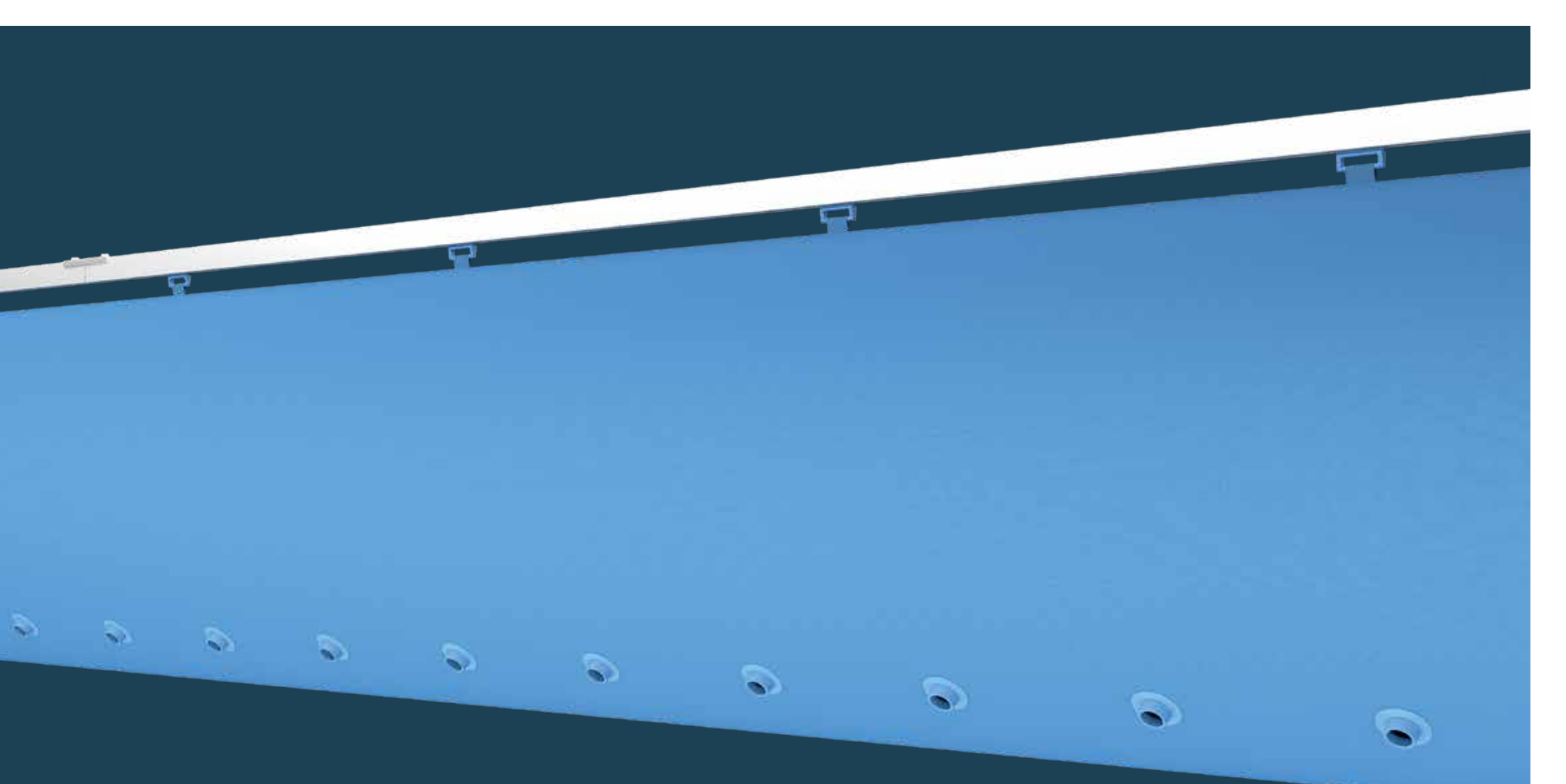

Example of Typical Application: Spot cooling at 7m [23 ft], ΔT of -7K [-12.6°F] and 120 Pa [0.48 inwg] static pressure. The air is delivered exactly where it is required – marked by the highlighted box.

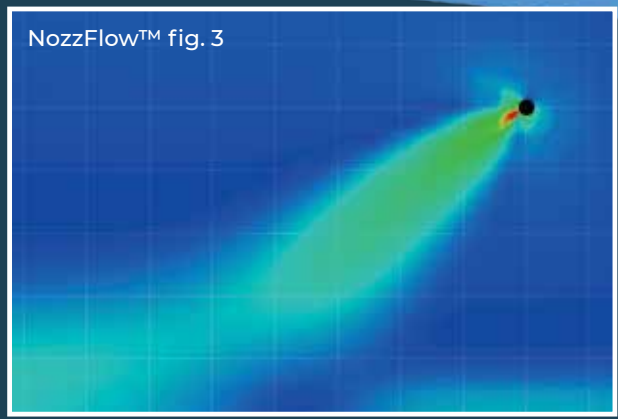
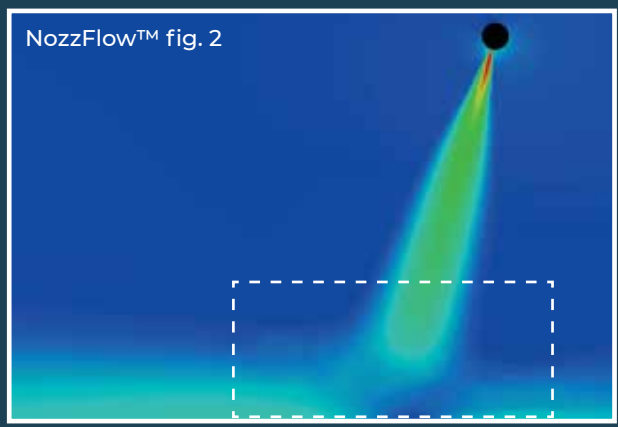

ΔT impact on air pattern

Example: Air pattern in cooling at ΔT of -6K [-10.8°F] and 120 Pa [0.48 inwg] static pressure.

JetFlow™

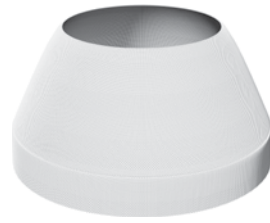

JetFlow™ can generate exceptionally long throws with perpendicular directionality, which enable a high level of precision. The supply air is accelerated through the reduced diameter of the jet, which is why JetFlow™ offers exceptionally high discharge coefficients compared to equivalently sized orifices.

As a primary flow model, JetFlow™ is often used in applications with a need for long throws with precise directionality, such as stadiums, arenas, large industrial facilities and very high storage facilities – all with a demand for exact throws with predictable temperature gradients and terminal velocities.

Jets are tailored in matching fabric. Jets are zipped in place, and if need be they can be capped at a later point.

Air discharge through JetFlow™ jet at 120 Pa [0.48 inwg] static pressure.

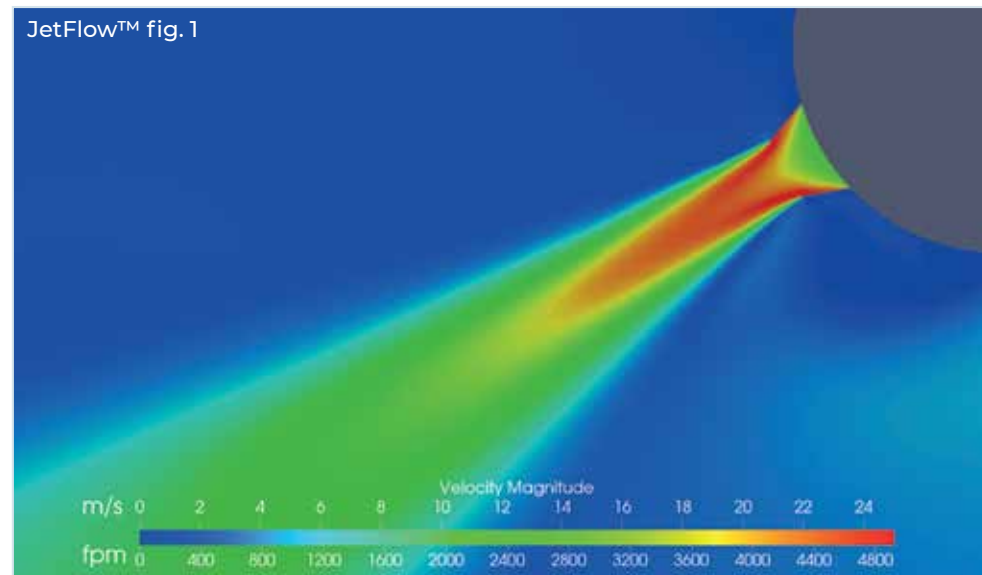

The flow is accelerated due to the conical shape of the jet. The acceleration rate depends on the size of the jet and the static pressure inside the duct. As the discharge coefficient is very close to 1.0, it is possible for the supply air to penetrate the space with high precision at very long throws.

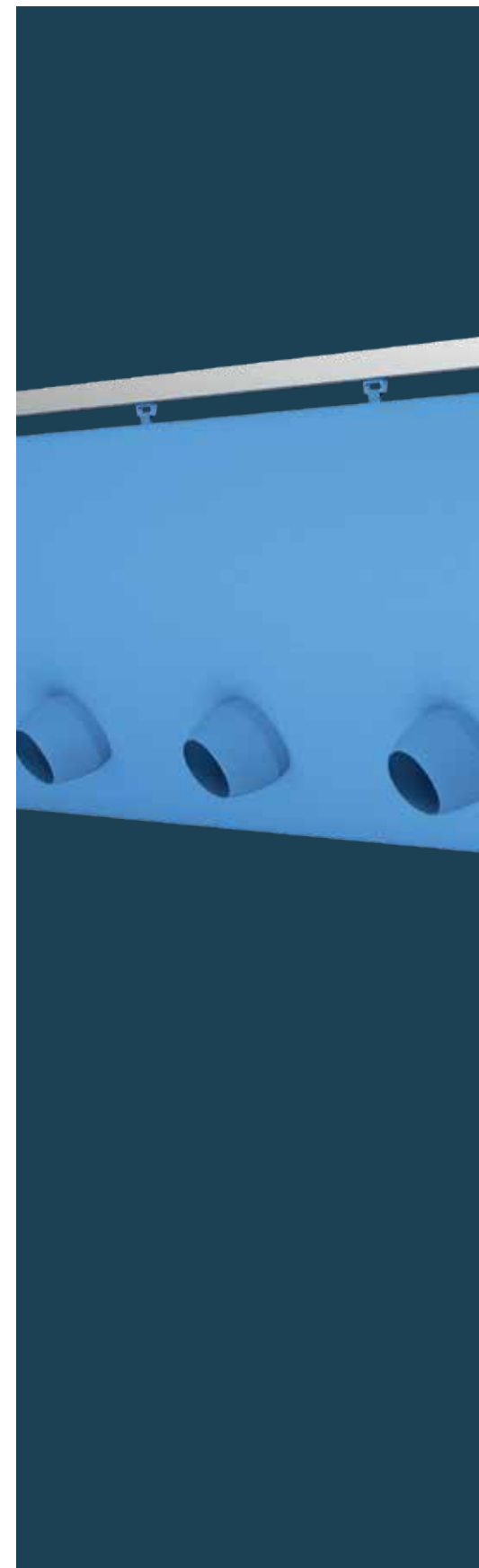

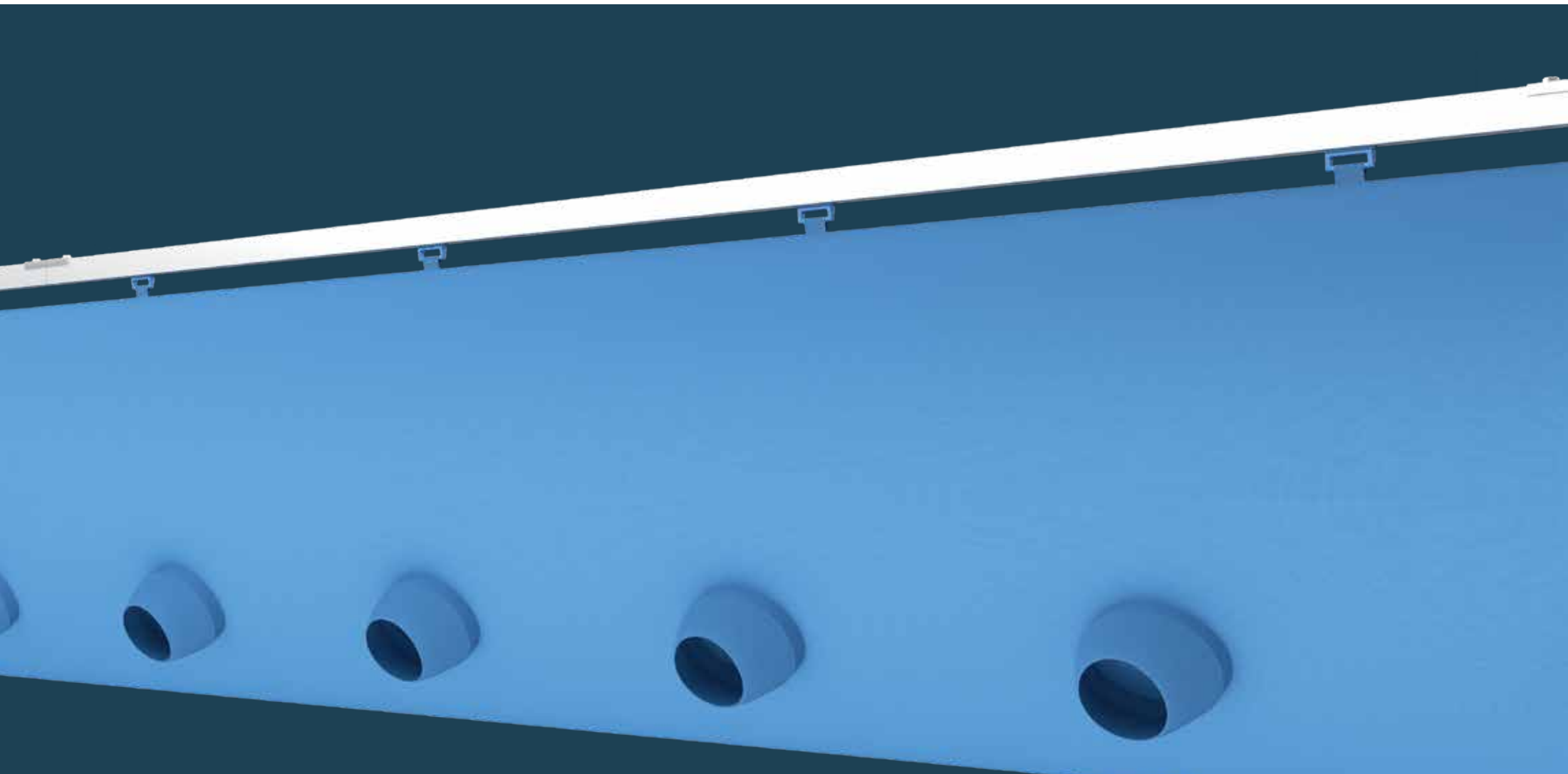

Example of Typical Application: Heating at 15 m [≈50 ft], ΔT of +10 K [+18 °F] and 120 Pa [0.48 inwg] static pressure. Hot air reaches the occupied zone even in very high installations. The target zone is delineated by the black line 1.8 m [≈6 ft] above the floor.

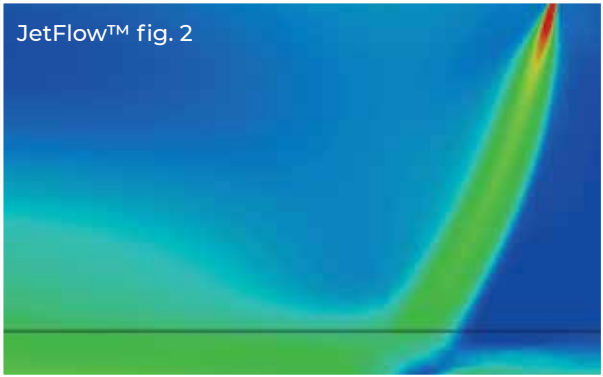

JetFlow™ fig. 3

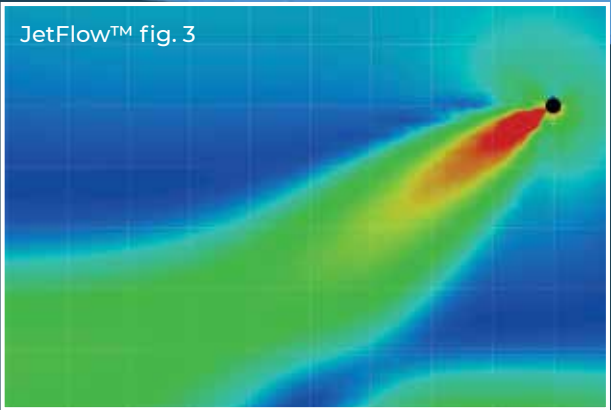

ΔT impact on air pattern

Example: Air pattern in cooling, ΔT of -6 K [-10.8°F] and 120 Pa [0.48 inwg] static pressure.

Cable Suspension

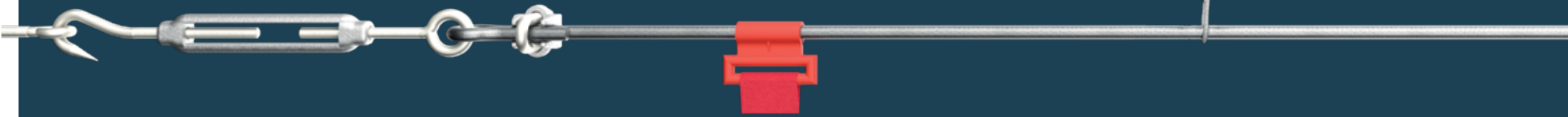

T-rail Suspension

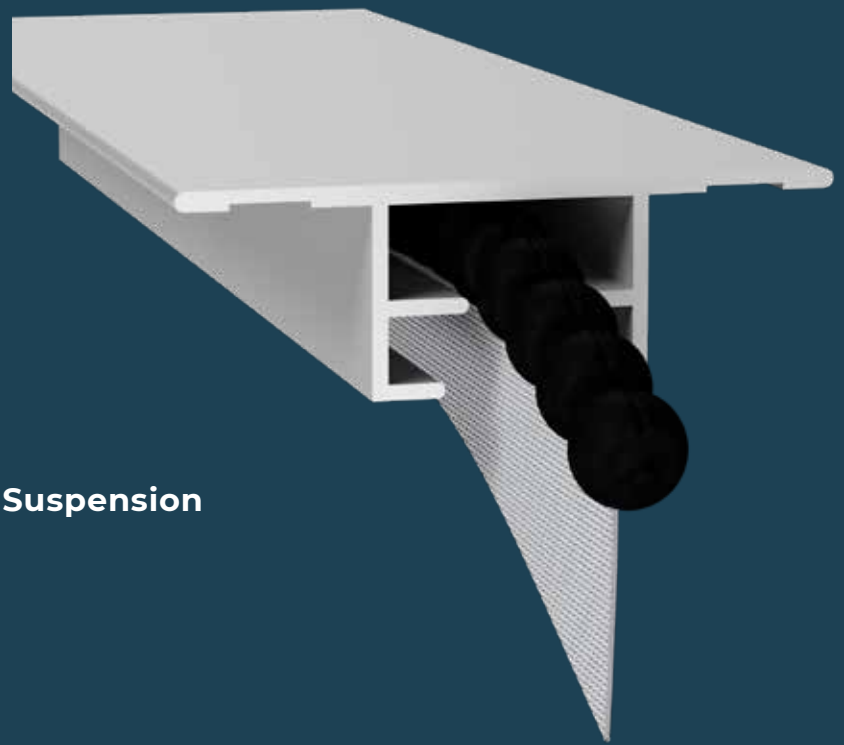

H-rail Suspension

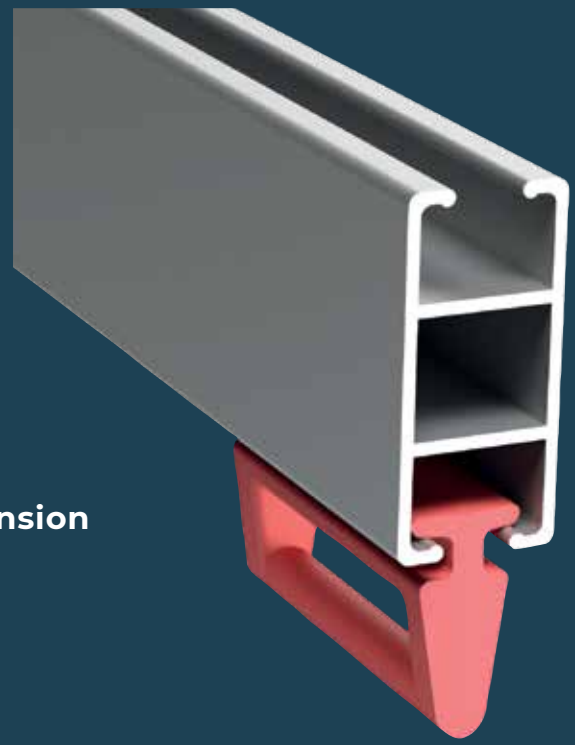

HANGING OPTIONS

Hooks

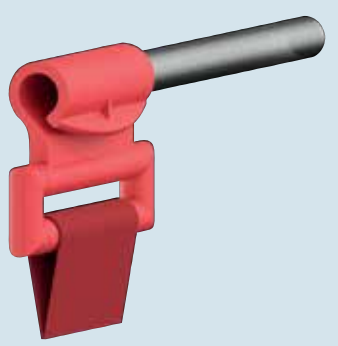

Bulb-edge



Plastic sliders





SUSPENSION SYSTEMS

FabricAir® provides a wide variety of suspension systems guaranteed to meet the challenges of any installation condition. There are three basic suspension systems: Cable, H-rail and T-rail.

The easy installation solution enables significant time and cost savings. The suspension types can be combined to create the ideal solution for each application.

Our suspension types are available in a variety of material options making them suitable for any application, including corrosive environments. The options include anodized aluminum, galvanized steel, stainless steel and hot-dip galvanized steel if stress corrosion cracking is a risk.

By combining suspension types, the custom dispersion system will suit any project regardless of its complexity, supporting vertical drops, bypassing existing piping and light fixtures, etc.

For non-standard suspension solutions please contact your local FabricAir® office. Contact information is found on the back of this brochure.

The RapidSlider simplifies installation for H- or T-rail suspensions. The feeder enables effortless sliding of any length of duct through the rail, resulting in a seamless appearance.

RapidSlider



Each suspension system offers a variety of hanging options that suit the needs of the space. See page 70-71 to view hanging options for each suspension type.

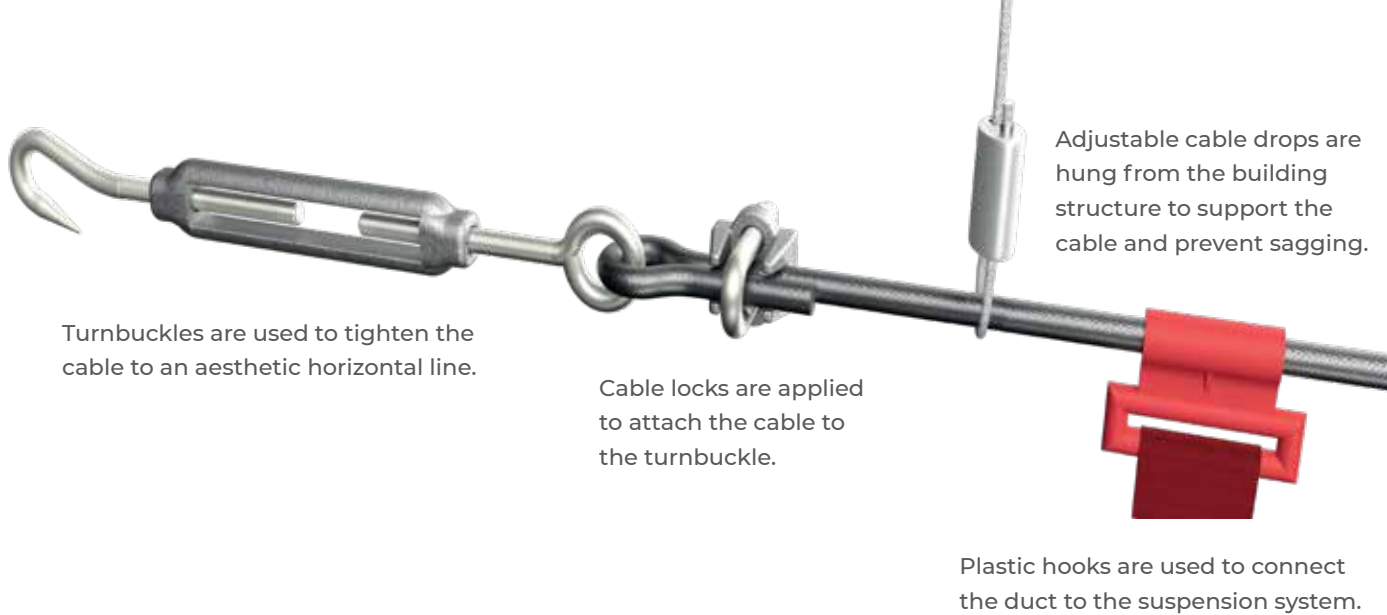

Turnbuckles are used to tighten the cable to an aesthetic horizontal line.

Cable locks are applied to attach the cable to the turnbuckle.

Adjustable cable drops are hung from the building structure to support the cable and prevent sagging.

Plastic hooks are used to connect the duct to the suspension system.

Cable Suspension

Cable suspension is a cost-effective solution used in single or double configurations. A stretched horizontal cable runs along the top of the duct, supported by intermediate vertical cable drops. The duct is attached using plastic hooks, and the length of the duct straps are manufactured to specification.

The cable is made from stainless steel or galvanized wire and, unless specifically requested, PVC coated for extra safety.

Stainless steel hardware includes turnbuckles and cable lock. This solution is very beneficial for corrosive or humid environments to ensure system longevity and safety.

The galvanized hardware option also includes turnbuckles and cable locks. Galvanized hardware is perfect in all non-corrosive environments.

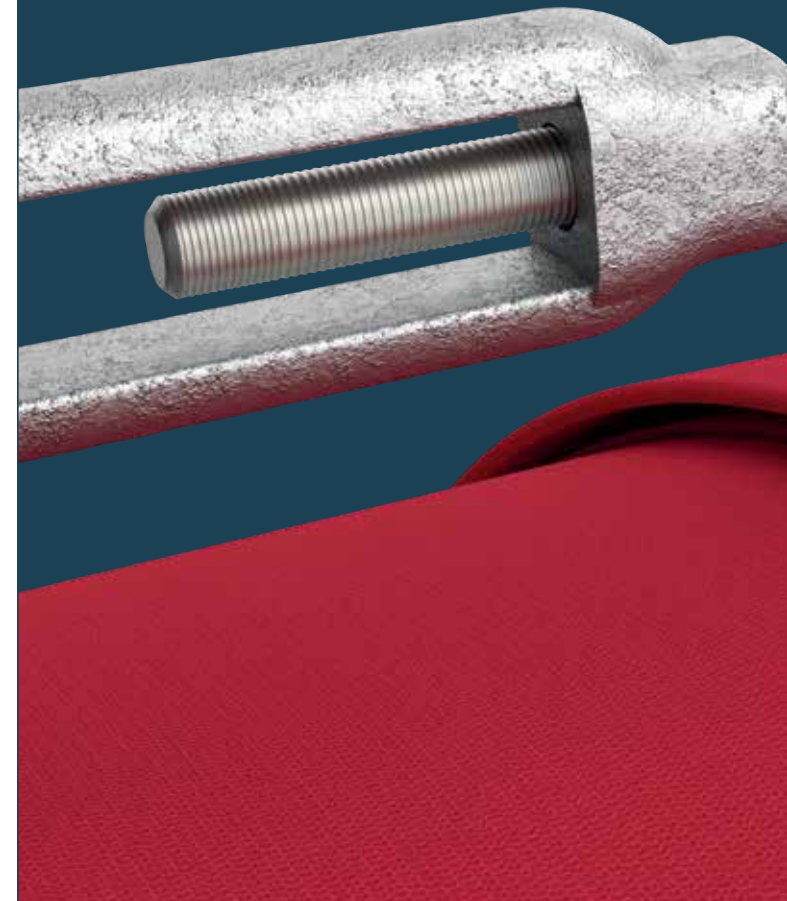

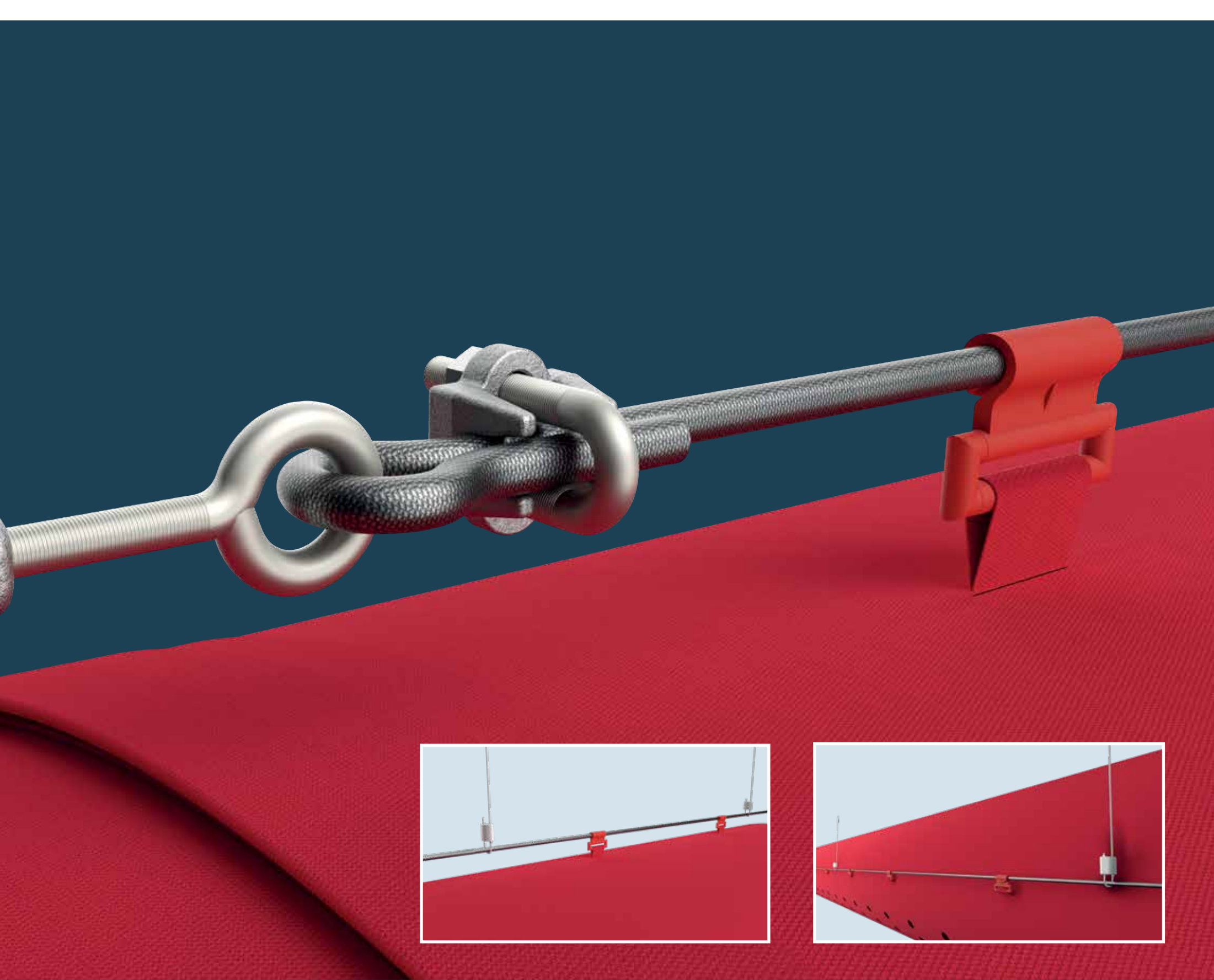

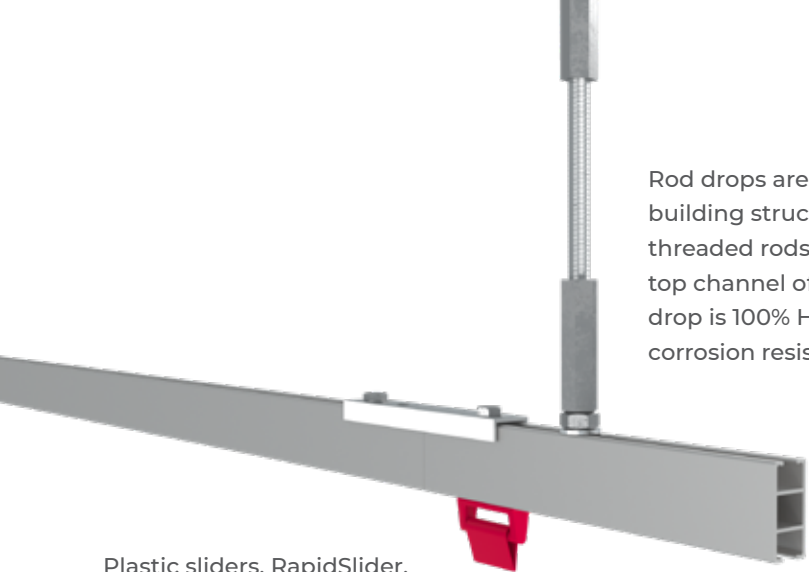

Rod drops are hung from the building structure. These are M8 threaded rods that lock into the top channel of the H-rail. The entire drop is 100% HDG creating a highly corrosion resistant design.

Plastic sliders, RapidSlider, or a bulb-edge are used to fix the duct to the H-rail.

HE Suspension

The HE (Harsh Environment) suspension systems are designed for use in harsh/corrosive environments. The solution is based on M8 threaded rods which are connected to the aluminum H-rails with a special connector.

The key is that all the critical elements in the HE suspension system are hot-dip galvanized ensuring a high level of protection against corrosion. Critical elements mean the weight load bearing fixings, fasteners, and threaded parts, i.e., all parts that are holding the weight of the air dispersion system.

The rods come in 2 m (6'5" ft) length. If the drop between ceiling and H-rail is longer, it can be easily extended by joining two rods together with a HDG coupling nut.

The duct will have plastic sliders or a bulb edge to slide into the H-rail.

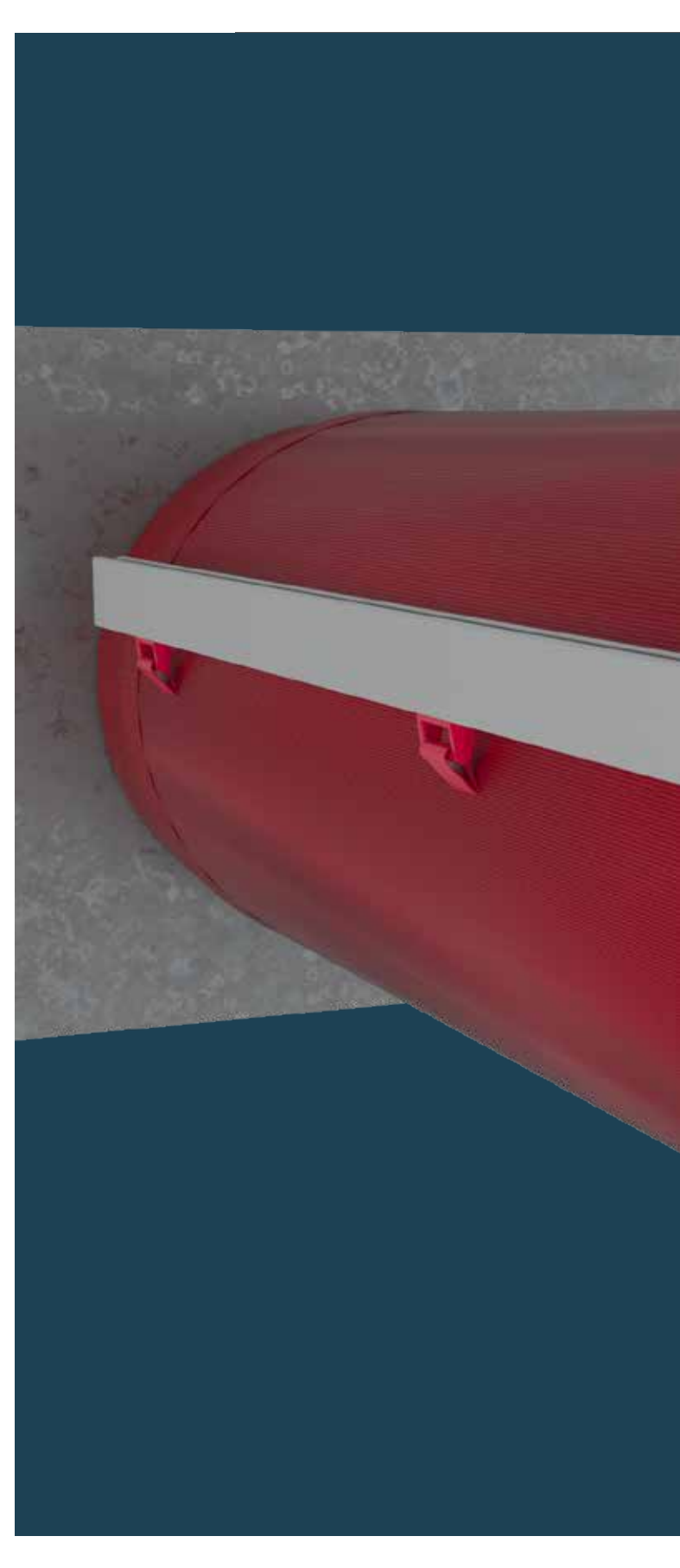

The HDG assembly joint connects two H-rail sections.

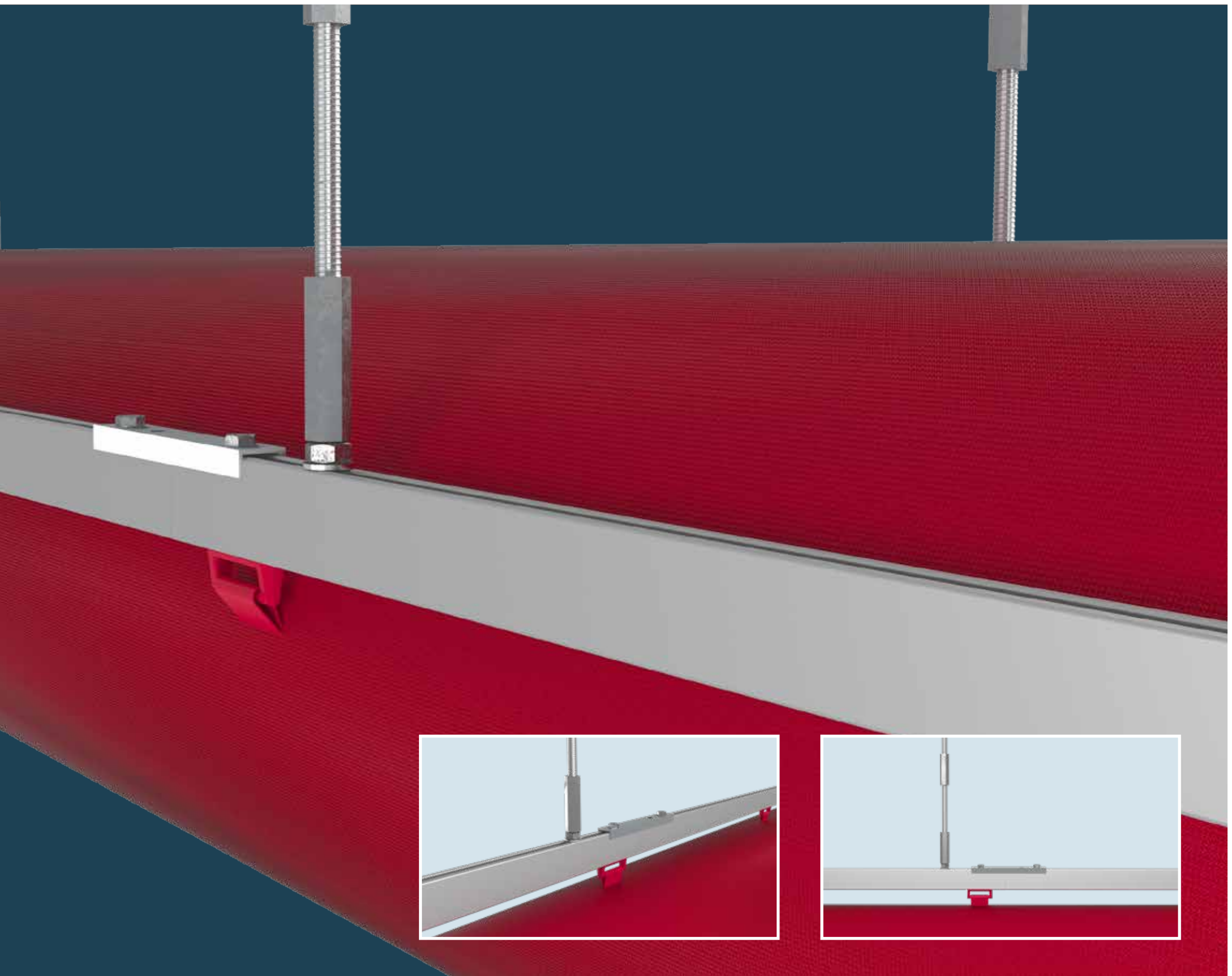

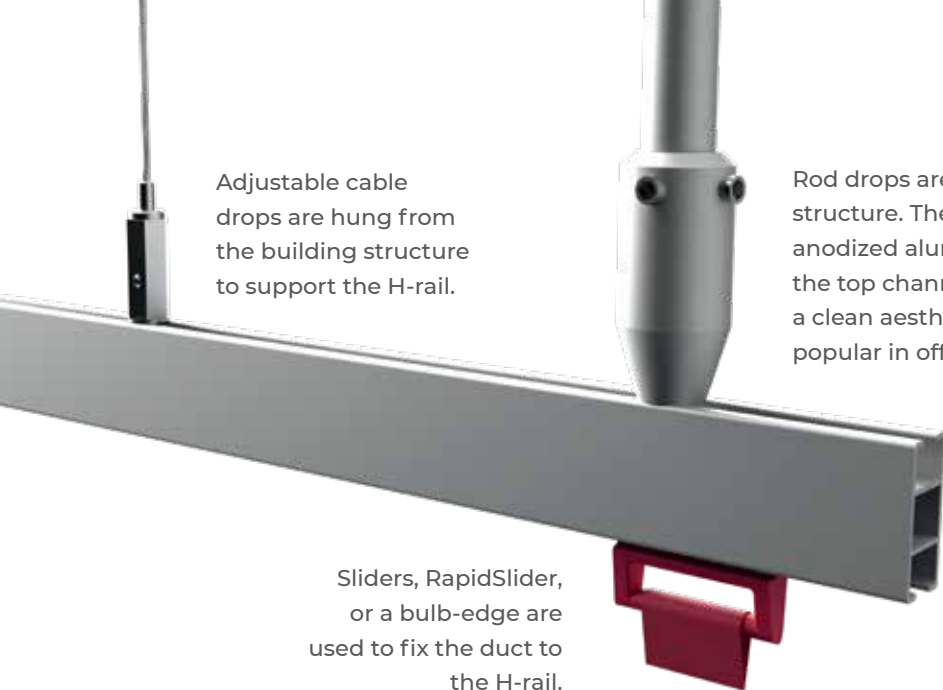

Adjustable cable drops are hung from the building structure to support the H-rail.

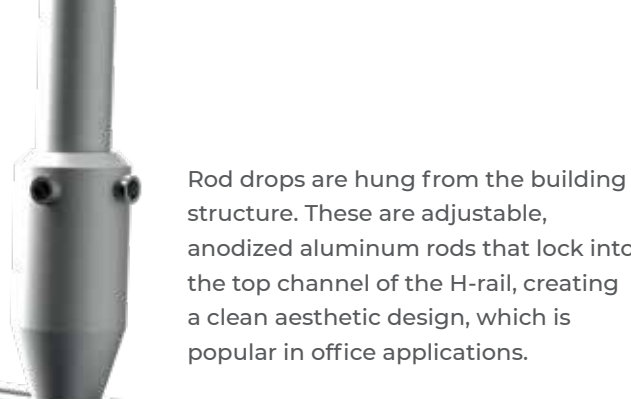

Rod drops are hung from the building structure. These are adjustable, anodized aluminum rods that lock into the top channel of the H-rail, creating a clean aesthetic design, which is popular in office applications.



Sliders, RapidSlider, or a bulb-edge are used to fix the duct to the H-rail.

H-rail Suspension

H-rail is commonly used to suspend complex FabricAir® Dispersion Systems, as these can be bent to suit the elbows. Curved rails are produced by bending our anodized H-rail to the exact angle necessary. H-rail is produced in 2 m [6 ft, 6 in] sections using an extrusion process and then anodized, making it an excellent choice for corrosive environments.

When assembling an H-rail system, the pieces of H-rail are joined together using an assembly joint, fastened to each rail using set screws. The H-rail is suspended using either a cable drop or rod drop from the structure.

H-rail suspension systems use either a single H-rail at the top of the ducts or two H-rails at the sides. The duct will have sliders, RapidSlider, or a bulb edge to slide into the H-rail.

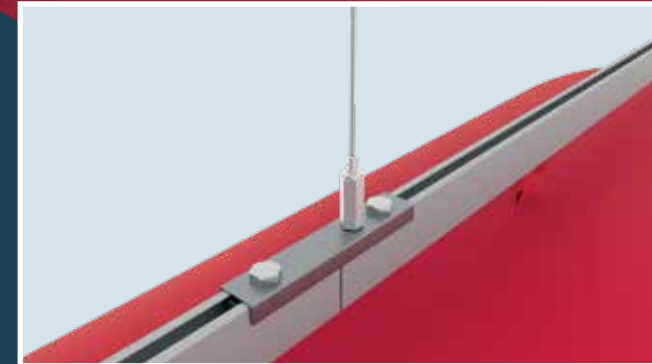

The assembly joint connects two H-rail sections. As an option the adjustable cable lock can be installed directly in the assembly joint.

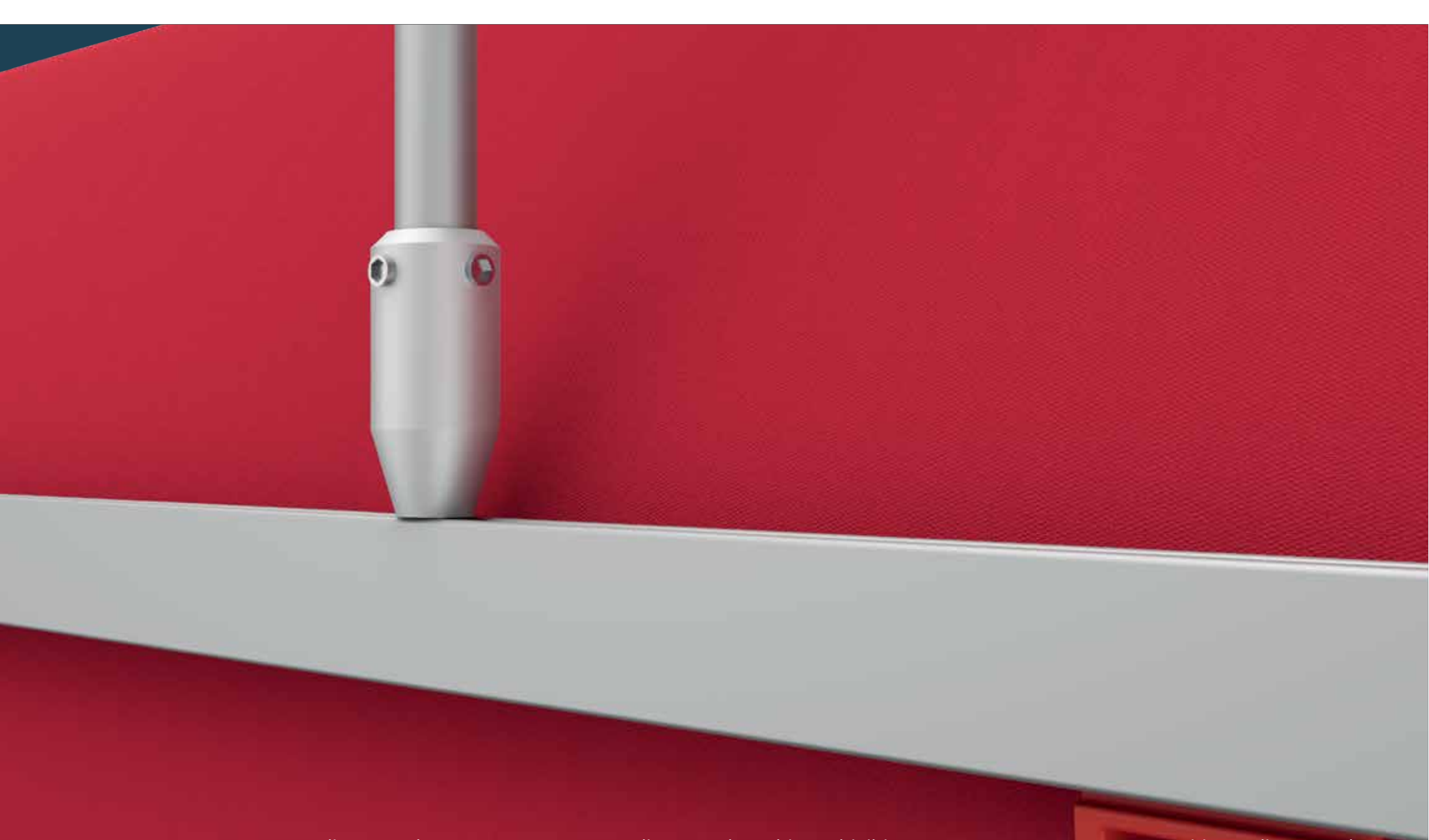

Type 08 H-rail Suspension



Type 07 H-rail suspension with RapidSlider

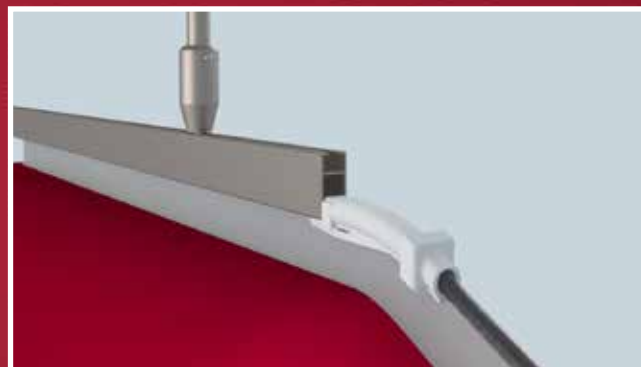

Type 13 Double H-rail Suspension





The end stop prevents the duct from sliding out of the rail when the supply air is turned on

Assembly joint

T-rail with slider and duct strap

T-rail Suspension

T-rail is attached directly to any type of ceiling or wall. The duct is suspended from the rail(s) using sliders, RapidSlider, or a bulb edge to slide into the T-rail profile. The height of the duct straps or bulb edge above the duct is manufactured to specification.

The softer bulb edge option can be pressed into the rail (Type 11) and the RapidSlider option slides into the rail (Type 11A).

T-rail is primarily used in a two-rail configuration to suspend D-shaped ducts, half-round and circle sections, although it is also well-suited for mounting round ducts. T-rail is produced in 2 m [6 ft, 6 in] sections using an extrusion process and then anodized, making it an excellent choice for corrosive environments.

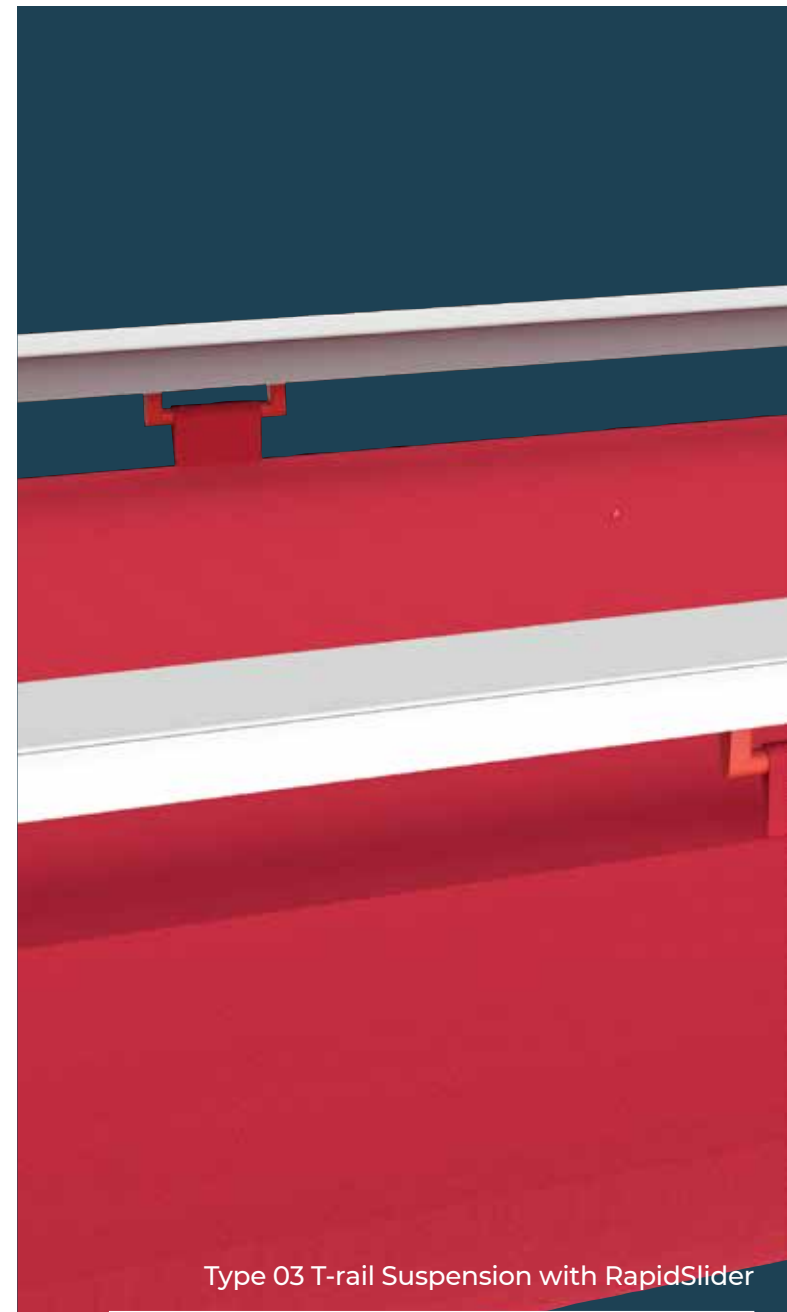

Type 03 T-rail Suspension with RapidSlider

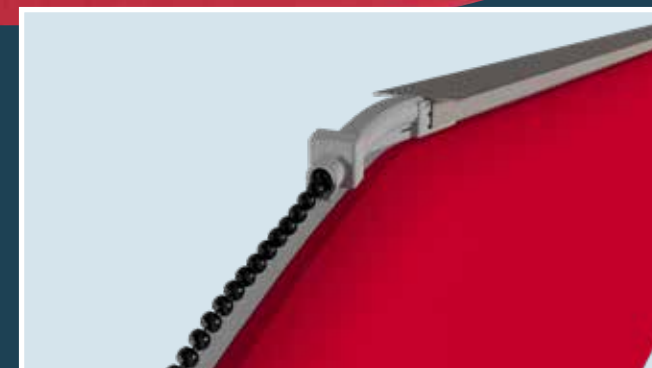

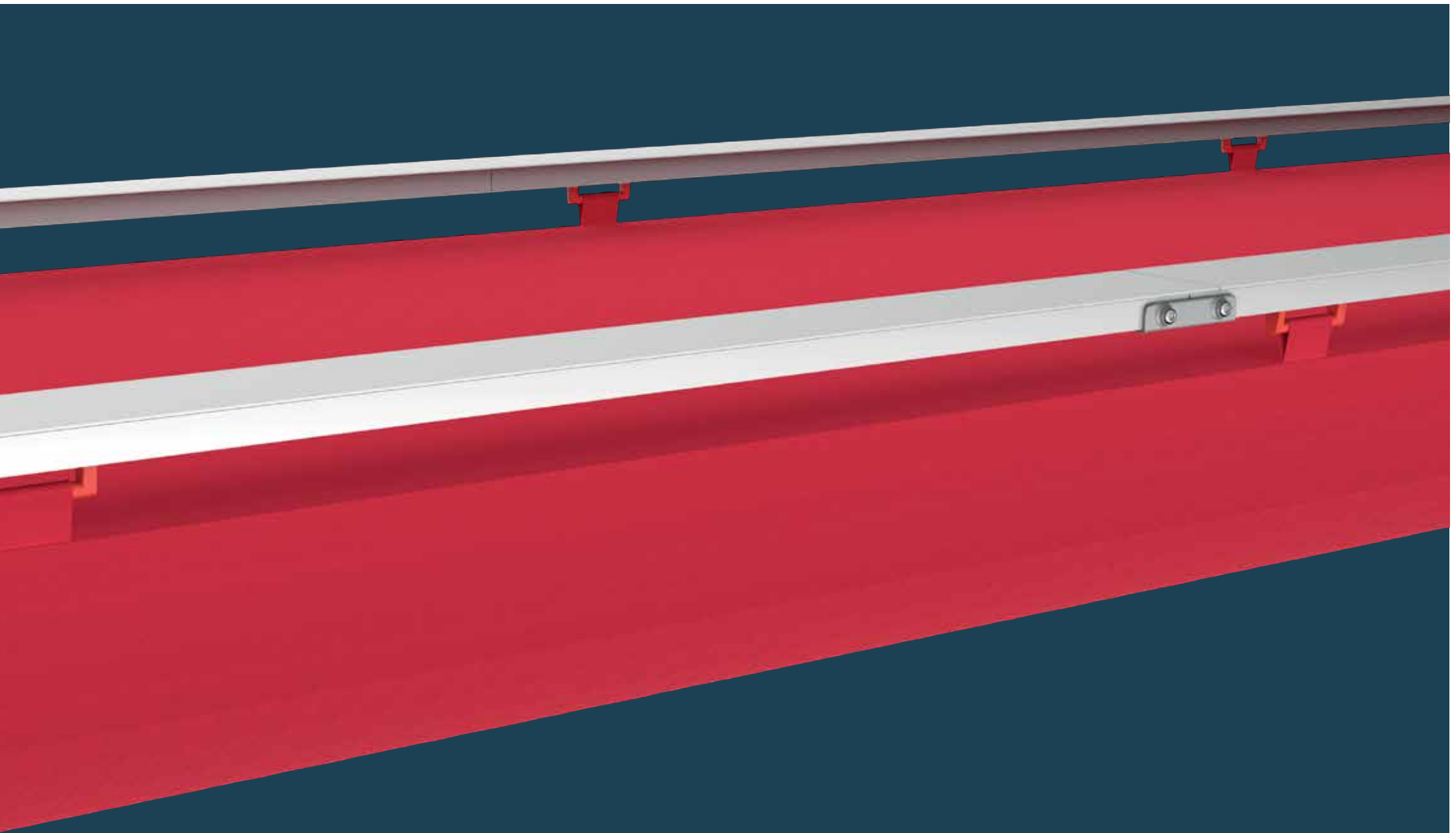

Type 03 T-rail Suspension

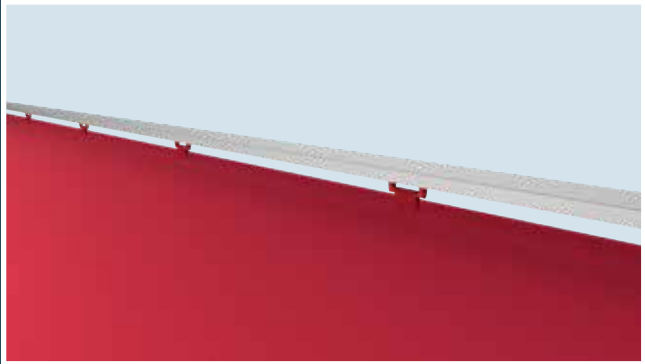

Type 11 T-rail Suspension with bulb-edge slider

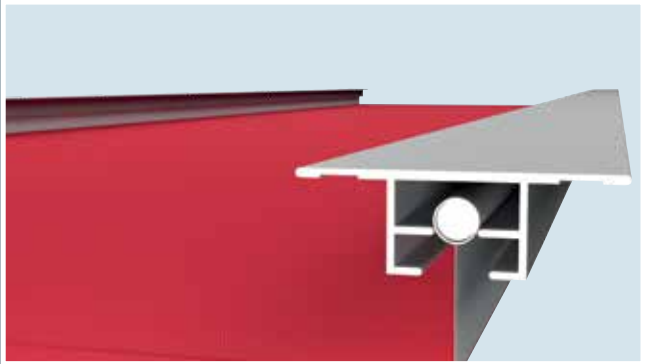

Type 04 Double T-rail Suspension

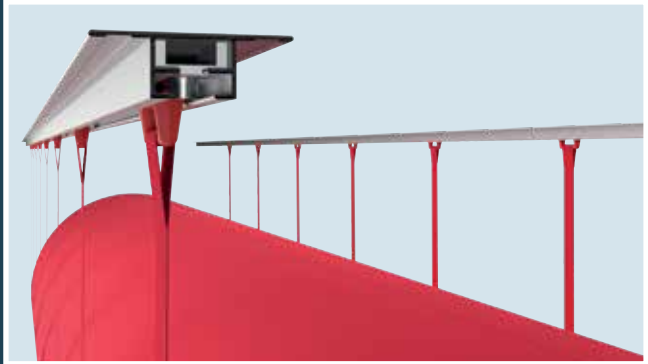

Overview: Suspension Types



| | | Type 1 | Type 2 | Type 3 | Type 4 | Type 5 |
|---|---------------------------|--------|--------|----------------------|---------|---------|
| Suspension Method | | Cable | Cable | T-rail | T-rail | H-rail |
| Fixed Directly onto Ceiling | | | | ✓ | ✓ | |
| Duct Hanging | | Hooks | Hooks | Sliders, RapidSlider | Sliders | Sliders |
| Material Options | 100 % galvanized steel | ✓ | ✓ | | | |
| | 100 % stainless steel | ✓ | ✓ | | | |
| | Aluminum/stainless steel | | | ✓ | ✓ | ✓ |
| | Aluminum/galvanized steel | | | | ✓ | ✓ |
| | Aluminum/HDG steel | | | | | ✓ |
| Duct Profiles | Round | ✓ | ✓ | ✓ | ✓ | ✓ |
| | D-Shaped / Half-Round | | | | | |
| | Circle Section | | | | | |
| | Rectangular | | ✓ | | ✓ | |
| Shape retention options (compatible with round duct profile only) | All-in-One | ✓ | | ✓ | | ✓ |
| | Internal 360° Hoops | ✓ | | ✓ | | ✓ |
| | Taut Endcap | ✓ | | ✓ | | ✓ |
| Specialty Duct | FabricAir® VarioDuct™ | ✓* | ✓ | ✓* | ✓ | ✓* |
| Installation of Classic Suspension Solutions | Quick installation | ☆☆☆☆☆ | ☆☆☆ | ☆☆☆☆☆ | ☆☆☆ | ☆☆☆ |
| | Elevations | ☆☆ | ☆ | ☆☆☆ | ☆☆ | ☆☆☆ |
| | Horizontal elbows | ☆☆☆ | ☆ | ☆☆☆ | ☆☆ | ☆☆☆☆☆ |

Contact your local FabricAir® office for information about customized suspension solutions. Find the information on the back of this brochure.



| Type 6 | Type 7 | Type 8 | Type 11 | Type 11A | Type 12 | Type 13 |
|----------------------|---------------------|----------------------------|------------------|--------------------|--------------------|-----------------------|
| H-rail | H-rail | H-rail | T-rail | T-rail | T-rail | H-rail |
| | | | ✓ | ✓ | ✓ | |
| Sliders, RapidSlider | RapidSlider | Sliders, RapidSlider | Soft bulb edge | RapidSlider | Sliders | Sliders, RapidSlider |
| ✓ ✓ ✓ | ✓ ✓ ✓ | ✓ ✓ | ✓ ✓ | ✓ ✓ | ✓ ✓ | ✓ ✓ |
| ✓ | ✓ | ✓ | | | | ✓ |
| | | | ✓ | ✓ | ✓ | |
| | | | ✓ | ✓ | ✓ | |
| ✓ | | | | | | |
| | | ✓ | | | | |
| | ✓ | ✓ | | | | |
| | ✓ | ✓ | | | | |
| ✓ | ✓ | ✓* | | | | ✓ |
| ☆☆ ☆☆☆ ☆☆☆☆☆☆ | ☆☆ ☆☆☆ ☆☆☆☆☆☆ | ☆☆☆☆☆☆ ☆☆☆☆☆☆ ☆☆☆☆☆☆ | ☆ ☆☆☆ ☆☆☆☆ | ☆☆☆ ☆☆☆ ☆☆☆☆ | ☆☆☆ ☆☆☆ ☆☆☆☆ | ☆☆☆ ☆☆☆☆ ☆☆☆☆☆☆ |

*All-in-One optional

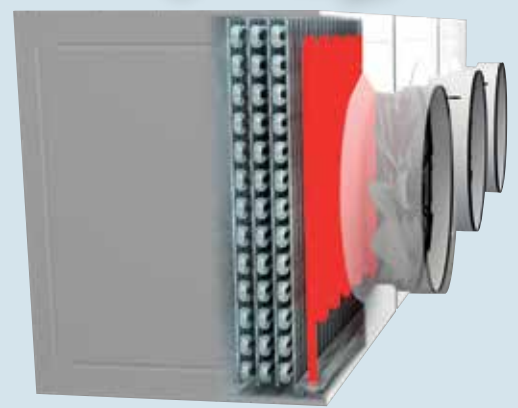
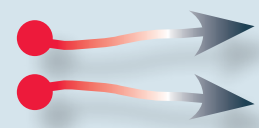
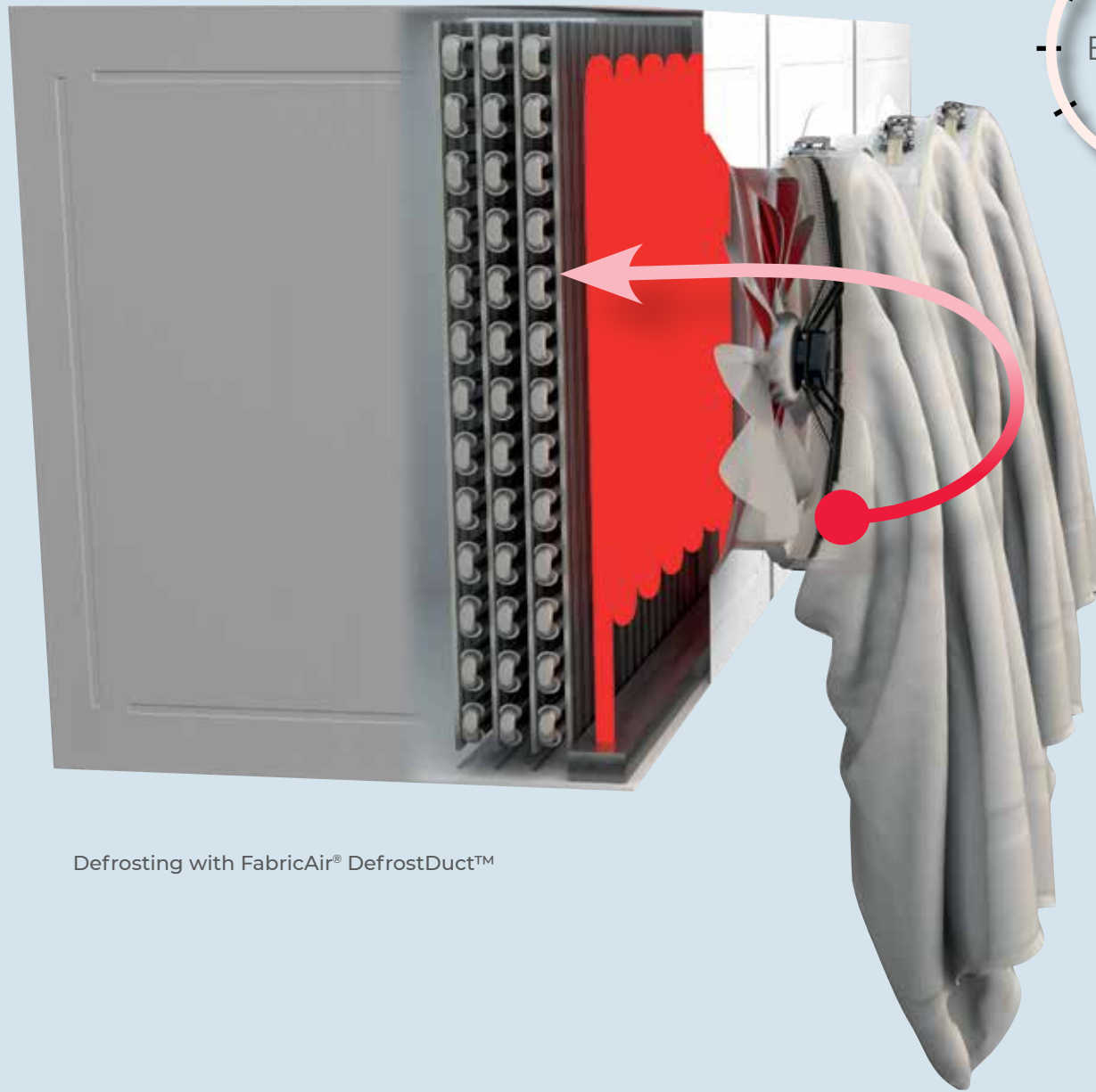

Defrosting with FabricAir® DefrostDuct™

Defrosting without the FabricAir® DefrostDuct™

SPECIALTY PRODUCTS

With almost 50 years of experience in innovating the HVAC industry, FabricAir® engineers understand that many industries require their own special solutions. In addition to the robust air dispersion systems with an array of duct profiles, FabricAir® offers specialty products to create the ideal fit for each application's specific requirements. Whether the application calls for different flow models for cooling/and or heating purposes in a single duct or reducing an evaporator's defrosting time by up to 50%, FabricAir® has the smart air solution.



FabricAir® DefrostDuct™

— SIGNIFICANTLY REDUCES THE EVAPORATOR'S DEFROSTING TIME

The FabricAir® DefrostDuct™ *reduces* the evaporator's defrosting time by 10 to 50%, thus increasing its efficiency.

When the evaporator reaches its defrost cycle, the FabricAir® DefrostDuct™ collapses, effectively sealing the outlet. By preventing the heat escaping from the air cooler, the efficiency of the defrost cycle is significantly increased.

Clever use of materials prevents water droplets caused by the defrosting cycle from freezing on the fabric surface.

ADVANTAGES

- REDUCES DEFROSTING TIME BY 10-50%
- LOW PRESSURE DROP
- SAVES ENERGY
- PRESERVES STORED GOODS BETTER
- PREVENTS ROOM TEMPERATURE FLUCTUATIONS
- LONGER THROW LENGTH

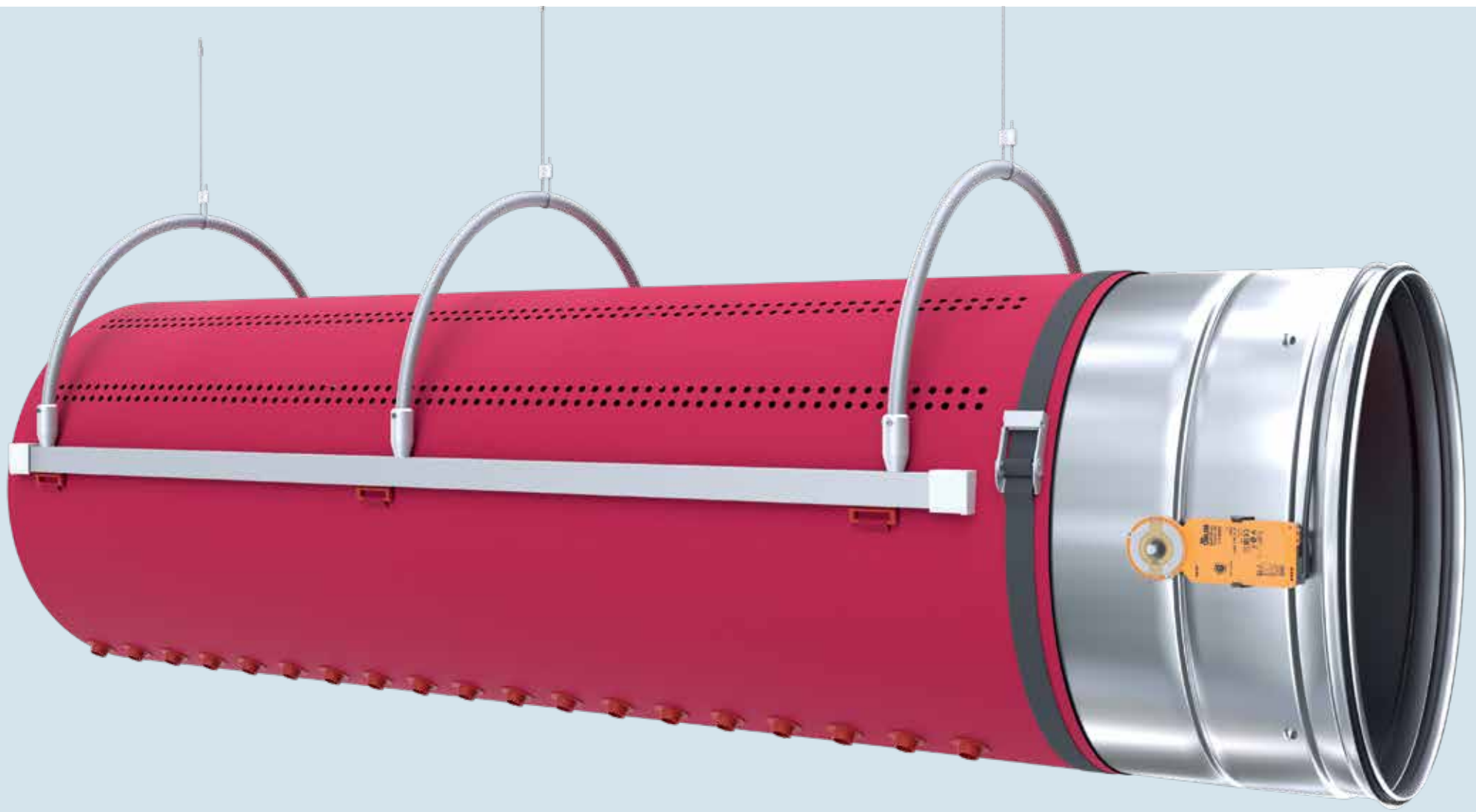

Upper section of the FabricAir® VarioDuct™ is typically designed for cooling.

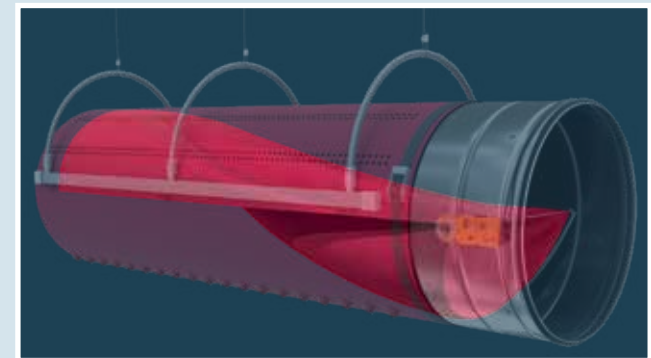
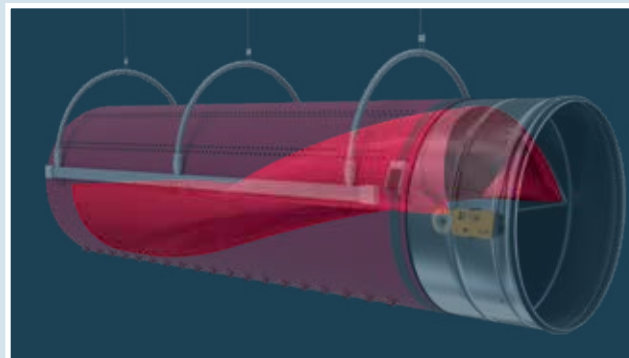

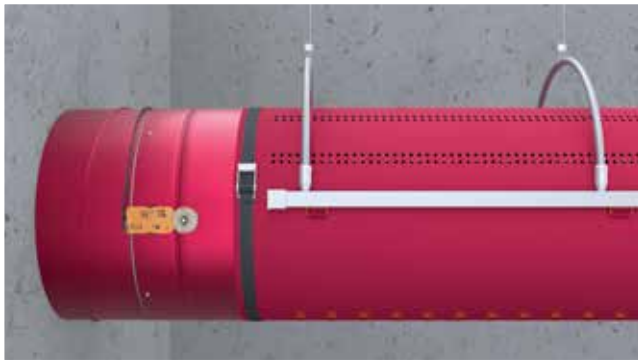

The color of the damper can be matched to the fabric to create an aesthetically pleasing look.

Lower section of the FabricAir® VarioDuct™ is typically designed for heating.



FabricAir® VarioDuct™

— TWO AIRFLOW SOLUTIONS IN ONE DUCT

The FabricAir® VarioDuct™ provides different flow models for cooling and/or heating purposes. It is tailored with an internal membrane that separates the two airflows.

Depending on which flow pattern location is needed, a damper changes position and moves the internal membrane either up or down covering half of the duct.

The upper and lower sections can even be designed with their own unique static pressure and air volume to meet the specific requirements and comfort levels of the application.

ΔT may vary from low to high between the two sections. This is customized using differing flow models, thus ensuring a high level of comfort regardless of which section is in use.

The FabricAir® VarioDuct™ is available for any length of round duct including horizontal bends and concentric transitions. The color of the damper can be matched to the fabric.

ADVANTAGES

- HIGH HEATING AND COOLING CAPACITY
- NO COMPROMISE ON COMFORT LEVEL SWITCHING FROM HEATING TO COOLING
- FULL FLEXIBILITY WHEN IT COMES TO AIR VOLUMES, AIR PRESSURES AND TEMPERATURES
- EASY AND FAST INSTALLATION
- AVAILABLE WITH HORIZONTAL ELBOWS AND CONCENTRIC TRANSITIONS

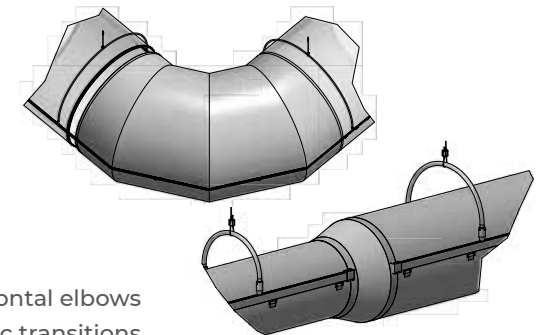

Also available with horizontal elbows and concentric transitions

FabricAir

Innovating the HVAC industry since 1973

FabricAir A/S

Køge, Denmark
(+45) 5665 2110
sales-dk@fabricair.com

FabricAir AS

Trondheim, Norway
(+47) 9349 1122
sales-no@fabricair.com

FabricAir GmbH

Wien, Austria
(+43) 1 9346162
sales-de@fabricair.com

FabricAir UAB

Alytus, Lithuania
(+370) 315 78 723
sales-lt@fabricair.com

FabricAir, Inc.

Suwanee, GA, USA
(+1) 502 493 2210
sales-us@fabricair.com

FabricAir España S.L.

Zaragoza, Spain
(+34) 876 097224
sales-es@fabricair.com

FabricAir (Qingdao) Co. Ltd.

Qingdao, China
(+86) 532 5552 0890
sales-cn@fabricair.com

FabricAir sp. z o.o.

Mikołów, Poland
(+48) 32745 6240
sales-pl@fabricair.com

FabricAir Ltd.

Rotherham, United Kingdom
(+44) 1709 835989
sales-uk@fabricair.com

FabricAir BV

Hoogvliet RT, The Netherlands
(+31) 181 848 397
sales-nl@fabricair.com

FabricAir AB

Malmö, Sweden
(+45) 5665 2110
sales-se@fabricair.com

FabricAir (Pty) Ltd.

Cape Town, South Africa
(+27) 21 203 0299
sales-za@fabricair.com

FabricAir Turkey A.Ş.

İzmir, Turkey
(+90) 232 446 34 58
sales-tr@fabricair.com

FabricAir GmbH

Berlin, Germany
(+49) 30 587407591
sales-de@fabricair.com

FabricAir Latin America S.A de C.V.

Silao, Guanajuato, México
(+52) 477 454 0410
sales-mx@fabricair.com

FabricAir Canada

Waterloo, ON, Canada
(+1) 519 885 6002
sales-ca@fabricair.com

smart air
solutions.

fabricair.com/contacts/

All rights reserved to FabricAir®, 2023.
The latest version can be downloaded from fabricair.com.

We are not responsible for printing errors,
nor for modified or discontinued products.

